

CodexpressTM

Data Communications Catalog  Spring/Summer 1989



codex
 MOTOROLA

**The finest datacomm
solutions for 27 years!
Call 800-446-6336.**

The Codex tradition of delivering the highest quality datacomm products and services goes on. In this issue of Codex Express, you'll discover several brand-new high performance products...find an expanded "Etcetera" section of other manufacturers' equipment...and learn about our new Codex Express Rental Program. Just the latest examples of the improved "quick-ship" products and services you'll continue to find through Codex Express!

"Our 27-year tradition of quality is reflected in the Codex products and services customers depend on today."

John Lockitt
President and CEO,
Codex Corporation



Codex's long-standing reputation as a datacomm leader signifies something very important to John Lockitt. "It tells me that quality and integrity make a difference," says John. "Those are values that Codex works hard to maintain, and it's gratifying to know that we're able to meet our customers' high standards."

John believes that the Codex commitment to quality is the single most important reason the company has been able to meet our customers' most demanding requirements for so many years. "It's a way of doing business that's been there from the beginning," says John.

"As part of the worldwide Motorola family," he notes, "Codex subscribes to a unique philosophy that pushes the entire organization to strive for the highest quality in everything we do. For example, our corporate-wide 'Six-Sigma' quality program drives us toward being virtually error-free in all aspects of our business.

"For Codex Express customers, that translates into reliable products, fast delivery, and the highest caliber applications assistance from the Helpline.

"But the important thing is what the Codex emphasis on quality can do for our customers' businesses—in the way of increased uptime, satisfaction from their customers, and the competitive edge that better and faster service will give them."

This symbol means instant savings 

Just watch for this special Gold Club symbol in the quantity column on selected product pages, then call us and ask how you can become an instant Gold Club member and take advantage of special discounts throughout the year. Or, if you prefer, simply complete and mail the enclosed reply form.

Motorola receives first annual Malcolm Baldrige National Quality Award

As a wholly owned subsidiary of Motorola, Inc., Codex is proud to share in the recognition given by the U.S. Dept. of Commerce for outstanding achievement in quality and an ongoing commitment to excellence.

It's further assurance that when you select a Codex product, you're choosing the highest quality.



C O N T E N T S

Introduction to Networking 4-7	2131/2132, p. 34
At a Glance Product Chart, p. 2	2130 Nest, p. 34
Analog Transmission, pp. 4-5	2020, p. 34
Digital Transmission, p. 5	
Networking, pp. 6-7	
Training Courses, p.8	
PC Modems9-11	
Introduction, p. 9	
FasTalk 1200E, p. 10	
FasTalk 2400II, p. 10	
Mirror II software, p. 11	
MicroPhone 1.5 software, p. 11	
Communications software cables, p. 11	
Dial Modems12-17	
Introduction, p. 12	
2234, p. 13	
2264, p. 14	
2264 Applications, p. 15	
2205, p. 16	
2206, p. 16	
2219, p. 17	
2221, p. 17	
Limited Distance Modems 18-22	
Introduction, p. 18	
2171, p. 19	
2111, p. 20	
2172, p. 20	
2123, p. 21	
Mileage Chart, p. 22	
Leased Line Modems23-31	
Introduction, p. 23	
2320/2340, p. 24	
2321/2341, p. 25	
2362, p. 26	
2382, p. 27	
2510, p. 28	
2500 Series, p. 29	
2600 Series, pp. 30-31	
Customer Service	
Digital Service Products ...32-34	
Introduction, p. 32	
2150, p. 33	
2160, p. 33	
	2131/2132, p. 34
	2130 Nest, p. 34
	2020, p. 34
	Multiplexers35-40
	Introduction, p. 35
	6015, p. 36
	6015 Applications, p. 37
	6003, p. 38
	6216, p. 39
	6228, p. 40
	Options41-48
	Introduction, p. 41
	2025, p. 42
	Analog Patch, p. 42
	2185, p.43
	Line Sharing Unit, p. 43
	2010, p. 44
	2207, p. 44
	Async/Sync Converter, p. 45
	6502, p. 45
	2000 Series Nest, p. 46
	Equipment Rack, p. 46
	Cables, p. 47
	6740/42/45, 9300 options, p. 48
	Etcetera49-56
	Introduction, p. 49
	V.35 Converters, p. 50
	Surge Suppressors, p. 50
	Breakout Boxes, p. 51
	212 Modem, p. 52
	Line Drivers, p. 52
	IBM Internal Modem, p. 53
	Switches, p. 54
	Reference Books, p. 54
	Communications Software
	and Cables, p. 55
	Patch Panel, p. 56
	Customer Service57
	Codex Direct Sales Offices ..58
	Terms and Conditions59
	Order Planning Guide60



The Codex V.32 modem protects your data with MNP error correction at speeds up to 9600 bps and more!

The Codex 2264 V.32 modem delivers performance in a host of applications. Faster data rates over dial lines save you time and help you get more productivity out of your existing network. And in leased line mode, the Codex 2264 provides dial backup in the event your leased lines fail. Other features include full V.32 and V.22 bis-compliant, MNP 4 error correction, automatic correction at all speeds, and more.

Now you can rent from Codex Express. It's easy, convenient and you build equity while you rent.

For short-term or seasonal needs or while you evaluate equipment risk-free, renting from Codex Express is an economical, convenient option. And if you later decide to purchase your Codex equipment, you'll have already built equity under the Codex Express Rental Plan.

Choose either a two-month or six-month minimum term at reduced rates. Standard product lead times apply so be sure to place your order early. Just call 800-446-6336 and ask us about the Codex Express Rental Plan.

At - A - Glance

Model	Compatibility	Data Rate	Operation	Available Options	Interface		Pg.*
					Terminal	Line	

Non-Network Controlled Leased Line Modems

2382	CCITT V.33, Codex	12,000 to 19,200 bps	sync/async, point-to-point leased line	4- or 6-channel mux, DDR	EIA 232-C, V.24/V.28	4-wire	27
2362	CCITT V.29, V.33, Codex	4800 to 14,400 bps	sync/async, point-to-point leased line	4-channel mux	EIA 232-C, V.24/V.28	4-wire	26
2341	CCITT V.29, Codex	4800 to 9600 bps	sync/async, point-to-point, or multipoint leased line	None	EIA 232-C, V.24/V.28	4-wire	25
2340	CCITT V.29	4800 to 9600 bps	sync/async, point-to-point leased line	4-channel mux	EIA 232-C, V.24/V.28	4-wire	24
2321	Codex V.29, Codex	2400 to 4800 bps	sync/async, point-to-point, or multipoint leased line	None	EIA 232-C, V.24/V.28	4-wire	25
2320	V.27 bis	2400 to 4800 bps	sync/async, point-to-point leased line	4-channel mux	EIA 232-C, V.24/V.28	4-wire	24

Economy Network Controlled Leased Line Modems

2560	CCITT V.33, V.29	4800 to 14,400 bps	sync/async, point-to-point leased line	4- or 6-channel mux	EIA 232-C, V.24/V.28	4-wire	29
2540	CCITT V.29, Codex	4800 to 9600 bps	sync/async, point-to-point, or multipoint leased line	4-channel mux	EIA 232-C, V.24/V.28	4-wire	29
2520	CCITT V.27 bis, Codex	2400 to 4800 bps	sync/async, point-to-point, or multipoint leased line	4-channel mux	EIA 232-C, V.24/V.28	4-wire	29
2510	CCITT V.26	1200 to 2400 bps	sync/async, point-to-point or, multipoint leased line	DDR	EIA 232-C, V.24/V.28	4-wire	29

Premium Network Controlled Leased Line Modems

2680	Codex	12,000 to 19,200 bps	sync/async, point-to-point leased line	Mux, DDR, X.25 PAD	EIA 232-C, V.24/V.28	4-wire	30
2660	Codex, V.29	4800 to 16,800 bps	sync/async, point-to-point leased line	Mux/MSU, DDR, X.25 PAD, Encryption	EIA 232-C, V.24/V.28	4-wire	30
2650	Codex	4800 to 14,400 bps	sync/async, multipoint leased line	DDR, X.25 PAD, Encryption	EIA 232-C, V.24/V.28	4-wire	30
2640	CCITT V.29	4800 to 9600 bps	sync/async, point-to-point, or multipoint leased line	Mux/MSU, DDR, X.25 PAD, Encryption	EIA 232-C, V.24/V.28	4-wire	30
2630	Codex	2 multipoint channels, total 9600 bps	sync/async, dual multipoint leased line	X.25 PAD, Encryption	EIA 232-C, V.24/V.28	4-wire	30
2620	CCITT V.27 bis	2400 to 4800 bps	sync/async, point-to-point, or multipoint leased line	Mux/MSU, DDR, X.25 PAD, Encryption	EIA 232-C, V.24/V.28	4-wire	30

Dial Line Modems

Model	Compatibility	Data Rate	Standard Features	Transmission	Interface		Pg.*
					Terminal	Line	
2206	CCITT V.29	4800 to 9600 bps	Dial or leased line	Sync only, half/full-duplex	EIA 232-C, V.24	2- or 4-wire	16
2205	Bell 208 A/B	4800 bps	Dial or leased line	Sync only, half/full-duplex	EIA 232-C, V.24/V.28	2- or 4-wire	16
2264	CCITT V.32/V.22 bis, Bell 212	1200 to 9600 bps	Dial or leased line with MNP**	Sync/async, half/full-duplex	EIA 232-C	2- or 4-wire	14
2234	CCITT V.22 bis, Bell 212, Bell103	300 to 2400 bps	Dial line; dial line MNP**	Sync/async, full-duplex	EIA 232-C	2-wire	13
2221	Bell 201 B/C	2400 bps	Dial or leased line	Sync/async, half/full-duplex	EIA 232-C, V.24/V.28	2- or 4-wire	17
2219	Bell 202S/T	1200 bps	Dial or leased line	Async only, half/full-duplex	EIA 232-C, V.24	2- or 4-wire	17
FASTALK	Bell 103, Bell 212 (1200); Bell 103, Bell 212, V.22 bis (2400)	300 to 1200 bps (1200); 300 to 2400 bps (2400)	Dial line	Async, full-duplex (1200); Sync/async, full-duplex (2400)	EIA 232-C	2-wire	10

Limited Distance Modems

2171/2123	43401/41028 Bell spec.	2400 to 19,200 bps	Quadrature Diphase and Diphase Modulation	Sync/async, half/full-duplex	EIA 232-C, V.24	2- or 4-wire	19,21
2172	41028 Bell spec.	30,48,56,64,72 and 80 kbps	Quadrature Diphase Modulation	Sync only, half/full-duplex	V.35	2- or 4-wire	20
2111	43401 Bell spec.	75 to 19,200 bps	Baseband Modulation	Async only, half/full-duplex	EIA 232-C, V.25 20mA	2- or 4-wire	20

Digital Service Units

2150	Bell DSU-500A or Bell DSU-500A/CSU-550A	2400 to 9600 bps	Digital (DDS service) & Codex network control	Sync/async, half/full-duplex	EIA 232-C, V.24/V.28	4-wire	33
2160	Bell DSU-500A or Bell DSU-500A/CSU-550A	56,000 bps	Digital (DDS service) & Codex network control	Sync/async, half/full-duplex	V.35 (DB25)	4-wire	33
2131	Bell DSU-500A or Bell DSU-500B/CSU-550A	2400 to 19,200 bps	Digital (DDS service)	Sync only, half/full-duplex	EIA 232-C	4-wire	34
2132	Bell DSU-500A or Bell DSU-500B/DSU-550A	56,000 bps	Digital (DDS service)	Sync only, half/full-duplex	V.35	4-wire	34
2020	AT&T 62310, 41450 & 41458	56,000 bps	ACCUNET (Switched 56k service) with Auto Dialer	Sync, half/full-duplex	V.35 Data, Dialer RS-232/366	2-wire	34

Multiplexers

Model	Muxing	Terminal Ports			Network Ports			Configuration Method	Throughput	Pg.*
	Technique	Number	Data Type	Speed	Number	Capability	Speed			
6003	Statistical	4 or 8	Asynchronous	Up to 9600 bps	1	Point-to-point	Up to 19.2 kbps	Control terminal or LCD front panel	3,000 cps	38
6015	Statistical	Up to 16	Synchronous or Asynchronous	Up to 9600 bps	1	Point-to-point	Up to 19.2 kbps	Local or remote control terminal	4,000 cps	36
6216	Bit, TDM	Up to 16	Synchronous or Asynchronous	Up to 19.2 kbps	1	Point-to-point	Up to 256 kbps	Control terminal	31,600 cps	39
6216 Enhanced	Bit, TDM	Up to 16	Synchronous or Asynchronous	Up to 19.2 kbps	2	Point-to-point	Up to 256 kbps	Control terminal or Codex network management system	31,600 cps	39
6228	Bit, TDM	Up to 56	Synchronous or Asynchronous	Up to 19.2 kbps	2	Point-to-point	Up to 256 kbps	Control terminal or Codex network management system	31,600 cps	40

X.25 Packet Assembler/Disassembler (PAD)

Model	Compatibility	Input Terminal Ports			X.25 Interface		Configuration Method	Certified	Pg.*
		# Ports	Data Type	Speed	Capability	Speed			
6502	CCITT X.25, X.3, X.28, X.29, and X.121	4, 10 or 16	Async	75 to 9600 bps	Point-to-point	Up to 9600 bps	Terminal	Telenet, Tymnet, Uninet, KDD Network Support	45

*See product page for complete description.

Remanufactured Products

Top-Quality Products at Rock-Bottom Prices

Now you can afford the high-quality data communications products you need.

Codex offers a variety of remanufactured equipment at a considerable savings. Products offered as remanufactured have been either demonstration models, non-renewed lease items, or previously leased

units returned by customers who have upgraded their entire systems.

All of these products are completely overhauled and rebuilt. Then they're tested to meet Codex standards. Then they're tested again. Before any remanufactured item is sold, it must conform to our strict quality assurance levels. Because new or not, they carry the Codex name. But that's not all they carry. . .

Every remanufactured product is backed by our unconditional 90-day Factory Repair and Return (FRR) warranty and in many cases, by a 12-month Factory Repair and Return guarantee.

All remanufactured products are shipped on an "as available basis." Please call for availability and for special volume discounts. **Prices are suggested list prices.**

Model	Compatibility	Features	Main Channel Data Rate	Modulation	Transmission	Line and DTE Interface	Product Code	Price
-------	---------------	----------	------------------------	------------	--------------	------------------------	--------------	-------

Dial Modems

5201R	Bell 201B/C	Dial or leased line	2400 bps	PSK	Sync, half-duplex dial or full-duplex leased line	EIA 232-C RJ 45 or RJ 11	25165	\$300
5212/ACU	Bell 212A	Automatic calling	1200/300 bps	300 bps-FSK 1200 bps-PSK	Full-duplex, dial	EIA 232-C RJ-11	25163	345

Leased Line Modems

CS9600	CCITT V.29, Codex	Point-to-point w/network control	9600/4800 bps	QAM	Sync, half/full-duplex	4-wire EIA 232-C V.24/V.28	23502	\$3,250
CS96FP	Codex	Multipoint w/network control	9600/4800 bps	QAM	Sync, half/full-duplex	4-wire EIA 232-C V.24/V.28	23503	2,895
CS4800	Codex	Point-to-point w/network control	4800/2400 bps	QAM	Sync, half/full-duplex	4-wire EIA 232-C V.24/V.28	23504	2,400
CS48FP	Codex	Multipoint w/network control	4800/2400 bps	QAM	Sync, half/full-duplex	4-wire	23505	2,045

Limited Distance Modems

8250	Codex	Point-to-point or multipoint	19.2 kbps 9600/7200/4800/2400 bps	Differential Diphase	Sync, half/full-duplex	EIA 232-C V.24	48253	\$ 475
8250 card	Codex	Point-to-point or multipoint	19.2 kbps 9600/7200/4800/2400 bps	Differential Diphase	Sync, half/full-duplex	EIA 232-C V.24	48268	375
8250 nest	Codex	—	—	—	—	—	48267	400

Analog Transmission

What is a modem?

A modem is an electronic device that enables computers and terminals to send and receive information over analog transmission facilities, such as telephone lines. Before any two computer systems can exchange information over an analog telephone line, a modem must be added at each end. During data transmission, modems convert data signals from digital form to analog and back to digital through a process called MODulation and DEModulation. With modems, data can be transmitted just about anywhere phone lines exist.

What kind of modem do you need?

Before ordering a modem, you must identify your data communications needs. To begin with, distance will determine whether you need a limited distance modem for a metallic line or a long haul modem for a phone line. You will also choose between a dial modem or a leased line modem depending on the volume of information you need to transmit and the type of application you're supporting.

Dial Transmission

If you're sending small amounts of data infrequently, you should consider a dial modem (see pages 9-17). Dial modems transmit data over telephone lines, so you can route your data to anyone with access to the telephone network. And, you're charged only for the line time you actually use—just like a regular phone call. What's more, a company's WATS line or special long distance service can often absorb the cost of dial transmission.

While dial modems can support high transmission speeds, error rates are usually higher when data travels over unconditioned dial lines. However, the exceptional quality built-in to all Codex dial modems along with features such as Automatic Adaptive equalization (which compensates for changes in line distortion) will insure the accuracy your business requires.

Using a modem to transmit digital data over analog telephone lines

The modem at the transmitting end converts the digital signal to analog so it can travel the phone line; the modem at the receiving end converts the signal back to digital for processing.

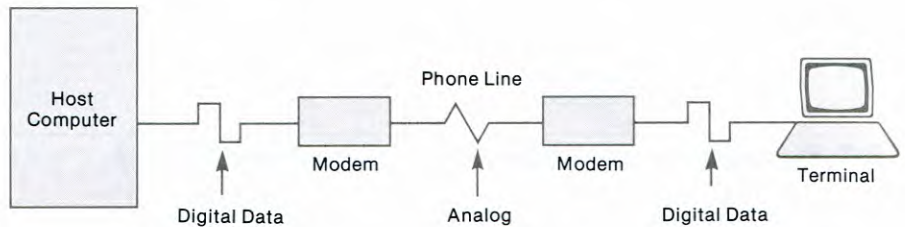

Leased Line Transmission

Leased line modems may be better suited to your needs if you're sending large amounts of information frequently, or if higher transmission speeds are required (see pages 23-31). They operate over a "dedicated" or private line that you lease from a common carrier like the phone company. By leasing a phone line, you can reduce some of the costs associated with long distance data transmission. And line distortion is reduced through a process called "conditioning," which offers greater protection from line demons such as the "phase hits" and "phase jitter" that often affect unconditioned lines.

Limited Distance Transmission

Limited distance modems are ideal for transmitting data over short distances, within a 26 mile range (see pages 18-22). They operate over twisted-pair wiring generally located within a user's own business complex or Telco-provided Local Area Data Channels. Some of the benefits of short distance transmission include its cost-effectiveness and the superior data integrity that can be achieved.

What mode of transmission?

Half-duplex or full?

In half-duplex transmission, data flows in both directions, but only in one direction at a time. A factor to consider is "line turn-around"—the time required for the line to "clear" before transmitting in the other

direction. Half-duplex operates over either two-wire (dial) or four-wire (leased) lines.

Full-duplex permits simultaneous transmission in both directions. Until recently, full-duplex operated only over four-wire (leased) lines or by using special modems to split the transmission channel of a two-wire dial line to create two, independent communication paths. Now, however, there are dial modems available that comply with the CCITT (Consultative Committee on International Telephone and Telegraph) V.22 and V.32 standards, offering two-wire full-duplex operation.

Sync or async?

In general, synchronous operation is more efficient, faster and more expensive than asynchronous operation. Therefore high-speed modems are usually synchronous, and low-speed modems are usually asynchronous. For high-speed applications, many modems have an asynchronous-to-synchronous converter option which permits asynchronous data to be transmitted via synchronous modems.

Analog Transmission Continued

**CALL CODEX EXPRESS
800-446-6336**

Value-added features to consider

Codex modems offer the widest range of value-added features and options for the greatest efficiency and operational flexibility. Below are some of these features. Whether you're just developing your network or you're a sophisticated user, there's a Codex modem that will meet your needs and fit your budget. For more complex network needs, consult your local direct sales office (see page 58).

- A **multiplexing** capability—offered as an option with some modems—can eliminate the need for multiple parallel telephone lines. In some applications, this capability allows more cost-efficient use of the modem and phone lines.

- A **multipoint** capability allows several terminals to share the same trunk phone line to help reduce line and modem costs.
- **Multiple speed selection** permits you to continue transmitting—even while the quality of the phone line is degrading—by falling back to a lower transmission speed to reduce the error rate (until line quality is restored).
- **Dial backup** allows you to switch from your leased line to a dial line in the event the private line fails in some way.
- **Self testing** features or **diagnostics** are a way of performing local and remote testing through the modem to determine if there's a problem in either the line or the modem.

- **Auto-call** automatically places calls for a modem on the dial network to eliminate operator intervention.
- **Auto-answering** automatically answers incoming calls while the modem is operating.
- An **asynchronous-to-synchronous converter** permits an asynchronous terminal to operate with a synchronous modem for greater transmission flexibility.
- **Strapping** options built into the modem can be activated by the user for a variety of functions. Strapping options include switching from half- to full-duplex operation; going from two- to four-wire transmission; or converting a point-to-point modem into a multipoint modem and vice versa.

Digital Transmission

Digital transmission offers an alternative to sending data over analog transmission facilities (conventional phone lines). DATAPHONE® Digital Service (DDS) is a leased, private line service offering point-to-point and multipoint digital data channels. It is a full-duplex, synchronous service offering transmission rates of 2400, 4800 and 9600 bps (subrate) and 56 kbps. The service is 100% terrestrial. First offered in 1974, it is now available in most areas of the United States. Individual telephone companies and independent carriers now offer the service under a variety of trade names such as Synchronet®, Quickwaysm and Digicom®.

What is a DSU/CSU?

With digital, instead of using modems, you transmit data with an integrated Data Service Unit/Channel Service Unit (DSU/CSU), such as the Codex 2150 for subrate DDS and the 2160 for 56 kbps service. This digital device is the interface between your computer

Digital Dataphone Service with combined unit

A DSU/CSU formats data terminal equipment digital signals to the form required for DDS transmission.

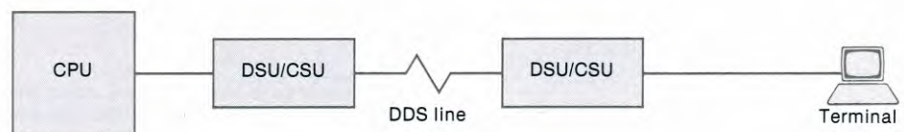

equipment and the digital network. The DSU portion converts the digital signals from the data terminal equipment to the form required for operation with the digital network, while the CSU portion is the circuitry designed as the interface to the digital lines. Because a DSU/CSU is a simpler electronic device than a modem, it can cost less to connect to a DDS line than to a leased analog line.

Advantages of digital transmission

Digital facilities utilize regenerative repeaters instead of the amplifiers used in analog transmission. Consequently the signals are reshaped without interference (noise, distortion, etc.)

This reduces errors and contributes to the 99.5% error free seconds and 10^{-7} bit error rate offered as "service guarantees" by the carriers. Digital transmission services, such as DDS, can be used with a variety of Codex multiplexers and DSU/CSUs to improve network efficiency. For example, the Codex 6003 and 6015 muxes provide data concentration with subrate DDS, while the Codex 6216 and 6228 muxes operate with 56 kbps DDS.

Digital transmission services, coupled with reliable Codex networking products, offer another option to consider as you build a data communications network.

Networking

What about expanding your network?

Initially, you may only need a few point-to-point connections carrying a low volume of information. In this case, dial modems will meet your needs, and for more demanding applications, you can easily upgrade to leased line modems. But as your operations expand, the cost of repeating a series of point-to-point networks—where each terminal is linked to the host computer by its own leased line—can be very expensive (Fig. 1).

The solution, in some instances, is to redesign or reconfigure the network into a multipoint network where several terminals share the same line (Fig. 2). This saves the expense of separate phone lines between each terminal and the computer. In other network environments, you may want to add “multiplexers” to further reduce your line costs.

Why multiplex?

Multiplexing helps to *reduce* the costs normally associated with expanding your network. For example, separate, standalone multiplexers can be an ideal way to minimize additional modem purchases and phone line charges when:

- You want more than two terminals to be able to transmit simultaneously over a single circuit.
- You want to mix synchronous and asynchronous terminals, and/or use different speed terminals.

How does multiplexing work?

Multiplexers, like modems, are used in pairs. The first multiplexer (or “mux”) combines several low-to-medium speed terminal transmissions into one high-speed analog or digital line. The second multiplexer at the other end of the line “demultiplexes” or converts the signal back into lower speed transmissions and routes each input to its designated computer port.

Modems are also used with the multiplexer to enable the connection

Fig. 1 Point-to-point network

A series of point-to-point networks where each terminal is linked to the host computer by its own phone line can be very expensive.

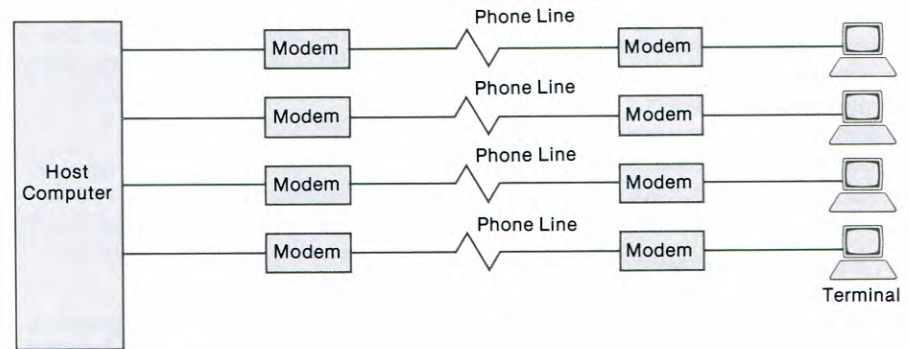
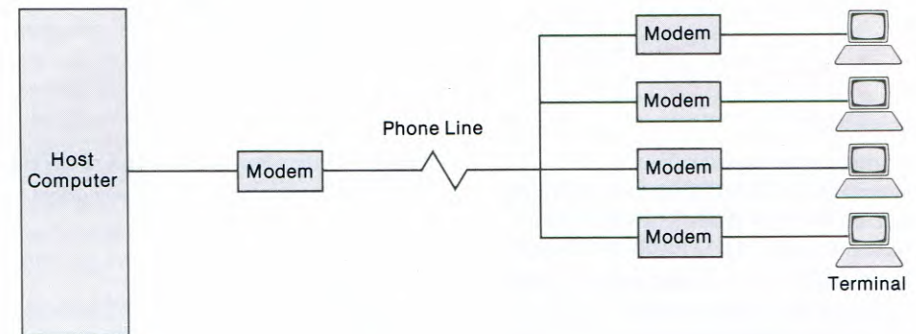

Fig. 2 Multipoint network

One solution for reducing line and modem costs is a multipoint network where several terminals share the same phone line. In this case, a multipoint configuration eliminates three phone lines and three modems.



to analog lines, while DSU/CSUs are used in conjunction with the multiplexer to transmit over digital facilities.

What kind of multiplexer do you need?

Both types of multiplexing—*statistical* and *time-division*—will help keep your costs down as you begin to enlarge your network. Which method is best for you depends on your applications, needs and budget.

Statistical multiplexing

Statistical multiplexers cut transmission costs by allowing you to support additional CRTs, word processors and other terminals on your

network while eliminating or reducing the need for additional lines and equipment.

They offer optimum line efficiency in applications where there is idle or “dead” time between transmissions. By allocating bandwidth “dynamically” to active terminals only, they ensure that when no data is sent, no time is allocated on the line. Because a “stat mux” can store data temporarily in a buffer memory during peak traffic periods, several terminals (with an aggregate input speed higher than the line) can be connected simultaneously. (Modems are used with statistical multiplexers to transmit over analog lines, and DSU/CSUs are used with stat muxes for transmission over digital lines.)

Networking Continued

Time-division multiplexing

Time-division multiplexers minimize delays and eliminate the need for buffer storage by using a "bit-interleaving" technique for data transmission. Each terminal is assigned a continuous, open slot on a high-speed line, whether or not it has something to transmit. And because

there is no waiting or buffer storage involved, the faster response times offered by time-division multiplexing are ideal for networks where slow response time directly affects business productivity. (DSU/CSUs are used with time-division multiplexers to transmit over high-speed digital circuits.)

One of the motivating factors for using digital links is their ability to accommodate growth at a comparatively low price. And because corporations are growing at increasingly higher rates, multiplexing over medium and high speed digital links can produce unprecedented levels of productivity.

How much money can you save with multiplexing?

Statistical multiplexing eliminates multiple parallel lines by merging the digital links at one end into one high-speed transmission line, then sorting them out at their destination. In this example, the Codex 6003 stat muxes (see page 38) reduce the network by three phone lines and six modems, resulting in a 65% cost savings to the network user.

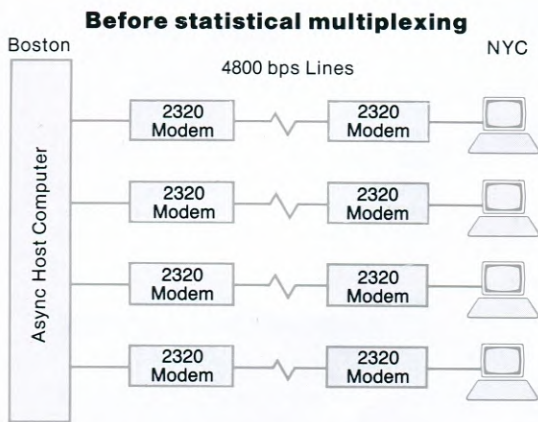

Monthly Telephone Charges (4 @ \$510) \$2,040
 Monthly Modem Charges (8 @ \$50) \$ 400
Total Monthly Charges \$2,440

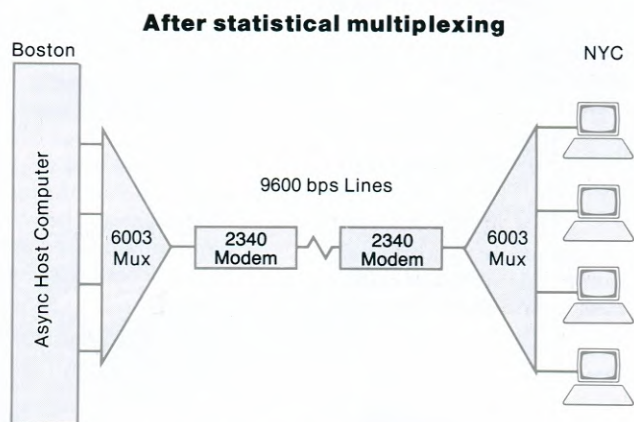

Monthly Telephone Charges (1 @ \$510) \$510
 Monthly Modem Charges (2 @ \$75) \$150
 Monthly Multiplexer Charges (2 @ \$45) \$90
Total Monthly Charges \$750
 Monthly Savings=\$1,690 (or a 69% reduction in monthly communication charges)

Time-division multiplexers, like stat muxes, can significantly reduce your network costs by eliminating the need for parallel lines. Here, the Codex 6216 muxes (see page 39) reduce the network by four lines and ten modems, while using two DSU/CSU units. The net result is a 25% cost savings to the customer.

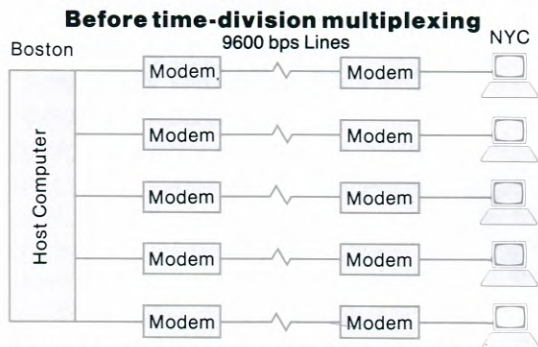

Monthly Telephone Charges (5 @ \$510) \$2,550
 Monthly Modem Charges (10 @ \$75) \$750
Total Monthly Charges \$3,300

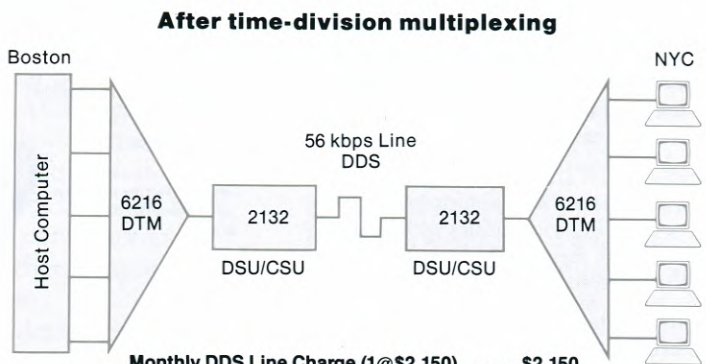

Monthly DDS Line Charge (1 @ \$2,150) \$2,150
 Monthly DSU/CSU Charges (2 @ \$30) \$ 60
 Monthly Mux Charges (2 @ \$165) \$ 330
Total Monthly Charges \$2,540
 Monthly Savings=\$760 (or a 25% reduction in monthly communication charges)

Note: Prices used are estimated. Modem and multiplexer costs are calculated on a three-year lease, representing typical equipment.

Training Courses and Self Study

Self-Study Courses

Codex self-study courses are designed to provide you with the knowledge and skills to help you be more effective in your job, as well as stay current on technological advances in the industry.

What's more, you'll benefit from the convenience of using these courses at your own location, over and over again, as a refresher or for training new personnel. And each completed course entitles you to Continuing Education Credits (CEUs).

Introduction to Data Communications

Use your IBM PC or PC-compatible to learn about basic data communications topics, including an overview of analog and digital communications and the function of modems in a network.

This four-diskette course runs on an IBM PC or PC-compatible with at least 256 kbytes of memory and a color graphics adaptor card.

Course Materials: 1 Student Guide,
4 Diskettes
CEUs: 0.7 units
Price: \$195



Interface Standards: EIA-232-C

This computer-based training course may be used as a continuation of Codex's "Introduction to Data Communications" or as a standalone lesson. You'll learn why an interface standard is needed and what are the mechanical, electrical and functional characteristics of the EIA-232-C interface.

This two-diskette course runs on an IBM PC or most PC-compatibles with at least 256 kbytes of memory and a color graphics adaptor card.

Course Materials: 1 Student Guide,
2 Diskettes
CEUs: 0.1 units
Price: \$65



Introduction to Protocols

A concisely-written guide to the formats and message exchanges of six of the most widely used protocols: Binary Synchronous, Uniscope, Burroughs 771, Burroughs Poll/Select, HDLC or SDLC.

Course Materials: One Workbook
CEUs: 0.5 units
Price: \$25

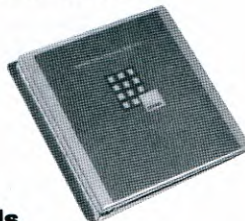

Control Signals and Interfaces

Designed for those who install, operate or test modems, this workbook is a good introduction to the process of communication between computers and communications equipment, and a helpful review of basic data communications concepts.

Course Materials: One Workbook.
CEUs: 0.5 units
Price: \$25



Codex 2600 Series Modems*

You'll learn how to install, operate the control panels and utilize the menus to configure and troubleshoot local and remote Codex 2600 Series Modems*.

Course Materials: 1 (1/2 inch)
VHS Videotape.
1 Workbook.
User Documentation.
CEUs: 0.7 units
Price: \$395

*See your local Codex Sales Representative (see page 30) to order Codex 2600 Series Modems.



Basics of Digital Voice Technology

NEW COURSE! This interactive program lets you become the communications manager of a company's network. You'll learn about voice networks and digital applications within those networks. This course (9+MB) runs on a Macintosh SE or Mac II with at least 20 MB hard disk (10MB free) and 2 MB RAM.

Course Materials: 1 Student Guide,
12 Diskettes.
CEUs: 0.7 units
Price: \$595 (quantity discounts available)

If your system cannot conveniently sustain this much memory, call (617) 364-2000, ext. 4193 and ask about renting an internal hard disk.

Classroom Courses

You can get the most from your communications equipment by attending a Codex classroom course. Conducted by technical professionals with teaching experience, these laboratory courses will provide you with practical, results-oriented skills that transfer easily "on the job." For additional information, or if you're interested in customer-tailored on-site courses, write to:

Codex Corp.
20 Cabot Blvd.
Mansfield, MA 02048-1193
Attn: Training Administrative
Coordinator M/S M3-30

or call: (617) 364-2000, X2225

PC Modems

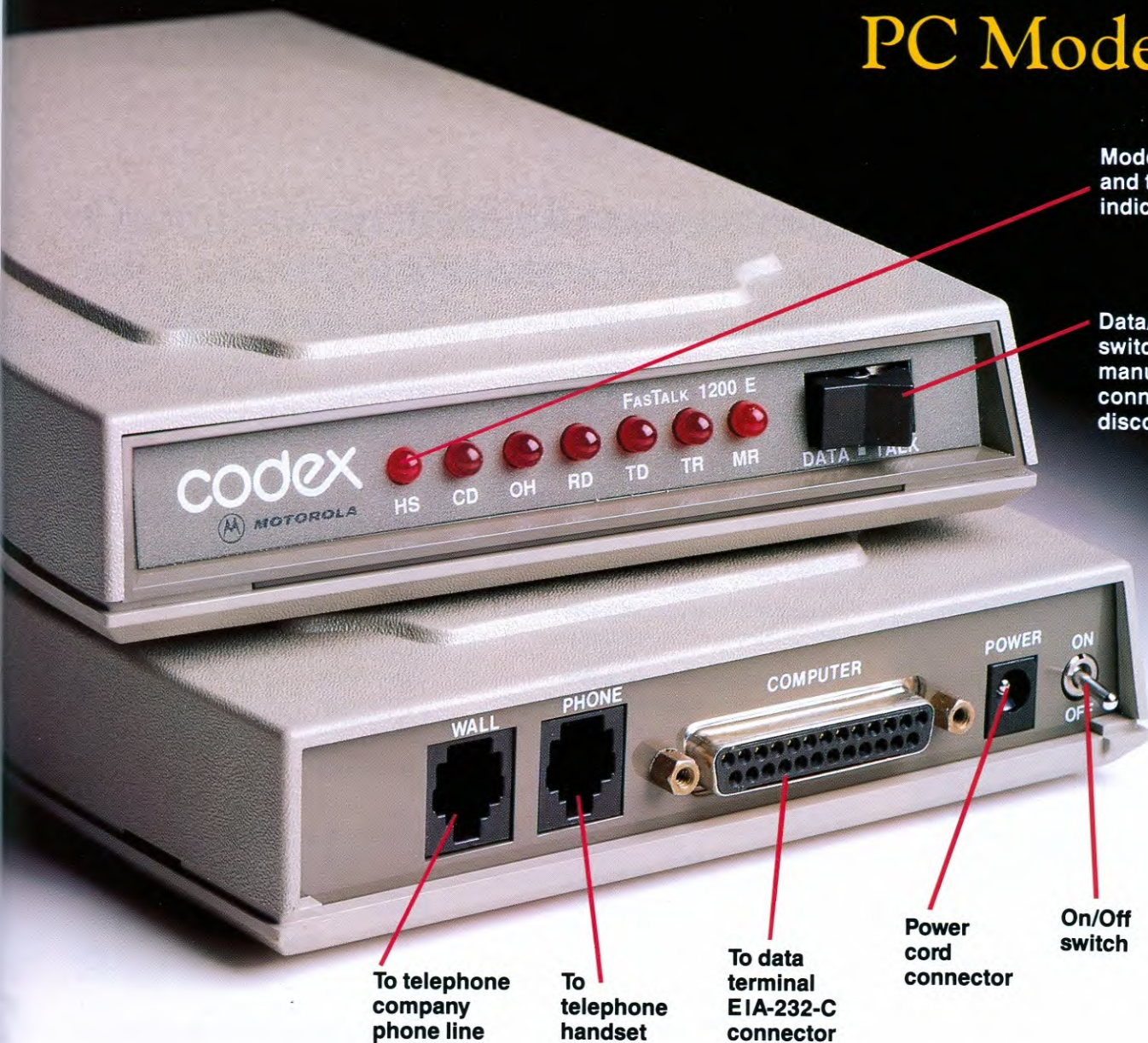

Modem status and testing indicators

Data/Talk switch for manual connect and disconnect

To telephone company phone line

To telephone handset

To data terminal EIA-232-C connector

Power cord connector

On/Off switch

Codex Express is pleased to offer two modems specially designed for PC communications—at prices you're sure to love!

And what better place to shop for a PC modem than from the recognized leader in high-performance modem technology?

What makes the Codex FasTalk 1200E and 2400II ideally suited to the wide variety of PC applications available today? First, they perform well under all kinds of phone line conditions, at speeds ranging from 300 bps to 2400 bps. That's exactly the kind of flexibility you need as you connect to other PCs,

mainframe databases, or a host of public network services around the country—like local bulletin boards, airline schedules and reservations, the Dow Jones News Retrieval, or the American Express Merchandise Shop. In fact, Codex PC modems can connect you to just about any other location that uses a dial modem.

Codex PC modems work with all IBM-compatible and Apple products, as well as with Hayes-compatible communications software. And we're pleased to also offer a selection of today's leading software packages for your convenience!

Plus, for a limited time, we're offering 25% off the software packages when you purchase either FasTalk modem!

These modems come with features you won't find with other comparably priced PC modems—including automatic dialing of preset, stored phone numbers, and a one-year warranty. They also sport a unique space-saving design that lets you place your phone right on top of the modem.

Questions about which modem is best for your PC setup? Our applications specialists are waiting to help! Just call 800-446-6336.

PC MODEMS



**CODEX
FasTalk
1200E**

**CODEX
FasTalk
2400II**

Two easy-to-use modems designed especially for today's PC applications.

SPECIFICATIONS

Data Rates: 300, 1200 bps async (1200E); 300, 1200, 2400 bps async/1200, 2400 bps sync (2400II).

Auto Calling Mode: AT command set (1200E is Hayes 1200 compatible; 2400II is Hayes 2400 compatible).

Dial Modes: Pulse or tone.

Transmitter Output Level: Permissive (-9dBm).

Telephone Line Interface: RJ11, RJ12, RJ13.

Power Requirements: 115Vac (external wall-mount transformer).

Size: 6 in. (W) x 1.4 in. (H) x 9.5 in. (D); Wt. 1.5 lbs.

Certification:

1200E 2400II

FCC Part 15B: AT996FFSTK12 AT996FFSTK24

FCC Part 68: AK396F-19279-MD-E AK396F-19462-MD-E

Ringer Equivalence: 0.4

UL approved

- Async transmission at 300 or 1200 bps (FasTalk 1200E)
- Async or sync transmission at 300, 1200, or 2400 bps (FasTalk 2400II)
- Bell 103/212A compatible; CCITT V.22 and V.22 bis compatible; also compatible with Hayes AT command set
- Compatible with all major communications software, including Crosstalk XVI, Procomm, SmartcommII, ASCII Pro, Mite, and others
- Dials, answers, and disconnects calls automatically (FasTalk 2400II can store up to 4 phone numbers in nonvolatile memory)
- Automatically adjusts transmission rate for incoming calls
- True call progress detection of busy, dial tone, ring, and connect signals; built-in speaker monitors call progress
- Front-panel LEDs allow easy troubleshooting
- Easy installation with one-page instructions; clearly marked switches and jacks for ease of operation
- For use with terminal, printer or computer system
- Compact size fits under standard desk phone
- Standard one-year warranty

TO ORDER

#25990	FasTalk 1200E modem	
	Qty. 1-9	\$295
	10-24	\$290
	25-35	\$280
	35+	GC
#25995	FasTalk 2400II modem	
	Qty. 1-9	\$395
	10-24	\$385
	25+	GC

See next page to order communications software and cabling.

Looking for an internal PC modem? See page 53.

Can you find the modem in this picture? It's just to the left of the computer.



Complete your FaSTalk connection with a communications software package and a PC-to-modem cable.

In order to communicate with other PCs, access bulletin board services, or perform file transfers, a PC requires communications software and a PC-to-modem cable. And we're offering two of today's leading software packages and cables to complete the connection to your FaSTalk modem.

Mirror II (from SoftKlone Distributing Corporation) is an asynchronous datacomm package that works with any IBM PC-compatible running Microsoft MS-DOS or IBM PC DOS operating systems. We recommend it because it does everything the popular Crosstalk XVI does, for a lot less money!

MicroPhone 1.5 (from Software Ventures) is the ideal software package for Apple users. You'll find it so easy to use, you'll hardly have to open the manual!

TO ORDER

- #25992 Mirror II communications software (5¼" floppy disk) \$70
- #25993 Mirror II communications software (3½" diskette) \$70
(Support provided by SoftKlone Distributing Co.)
- #25994 MicroPhone 1.5 communications software \$159
(Support provided by Software Ventures Inc.)
- #25980 IBM PC, XT or PS/2 cable (5 ft.) \$19.95
- #25981 IBM AT cable (5 ft.) \$19.95
- #25982 Apple-Mac Plus, SE or II cable (5 ft.) \$19.95
- #25983 Apple-Macintosh cable (5 ft.) \$19.95



Mirror II Communications Software

IBM-Compatible PC-to-Modem Cable



MicroPhone 1.5 Communications Software

Apple-Compatible PC-to-Modem Cable

Codex Express has a modem that's right for you . . . whatever your PC environment.

If your PC environment requires higher transmission speeds or runs critical applications that require error correction (like payroll, for example) Codex Express has a lot more to offer. Check out the Codex 2234 (page 13) . . . our MNP error correcting modem that helps ensure that critical data gets through even under adverse line conditions. Or the brand new

Codex 2264 (page 14) . . . our newly expanded V.32-compliant modem that also has MNP for reliable transmission at speeds up to 9600 bps.

Questions about which Codex modem or software package is best for you? Call the Helpline at 800-446-6336!

25% off PC Software with Codex FaSTalk modem purchase!

**CALL CODEX EXPRESS
800-446-6336**

Dial Modems

DIAL MODEMS

Switches for testing and problem isolation

Membrane switches for ease in configuration

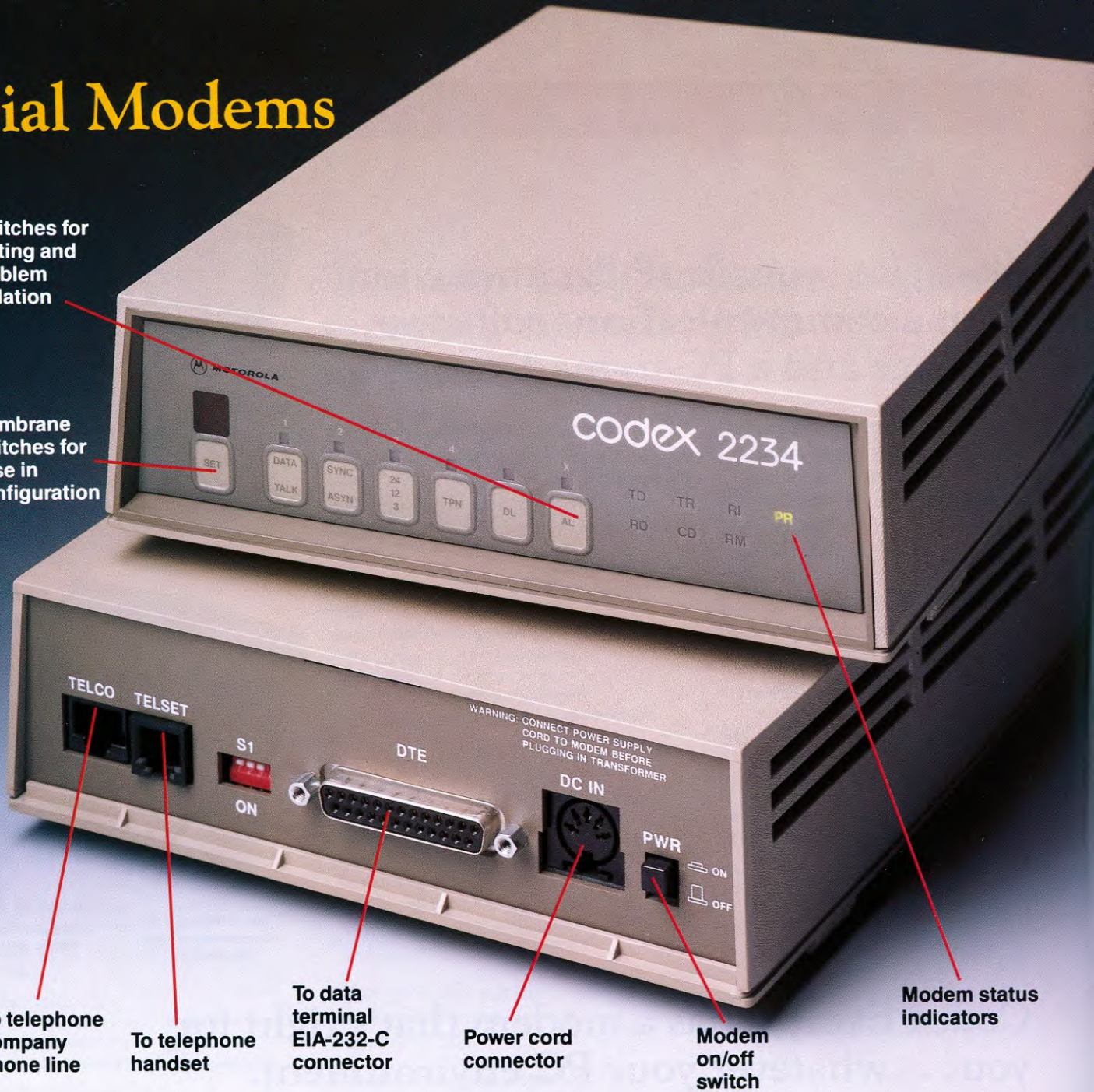

To telephone company phone line

To telephone handset

To data terminal EIA-232-C connector

Power cord connector

Modem on/off switch

Modem status indicators

Dial modems to satisfy the most demanding applications

Codex has been engineering leading-edge solutions in modem technology for over 27 years. For Codex Express customers, it adds up to unparalleled freedom of choice... with a selection of dial modems that runs the gamut from low-cost 1200 bps/2400 bps modems, to advanced 9600 bps modems that exceed international V.32 performance standards.

For example... the Codex 2234 has new Codex-enhanced

MNP error correction. It's the most flexible, responsive and reliable 2400 bps dial solution you can buy for your expanding "corporate" async/sync applications.

If you're planning on eventually upgrading to leased lines, the Codex 2205 and 2206 provide a remarkably cost-effective pathway that can handle both dial and leased line operation.

Finally, our Codex 2264 dial modem not only meets but surpasses the CCITT V.32 recommendation. This state-of-

the-art modem with MNP error correction delivers full-duplex operation at 1200 to 9600 bps. With Codex-pioneered long-haul echo cancellation and phase roll compensation for reliable long-distance communications. Plus, it's fully compatible with lower speed V.22 bis-type modems.

Call our applications specialists at 800-446-6336 and we'll demonstrate just how cost-effective Codex dial modems can be!

MNP error correction for error-free data transmission at 2400, 1200 or 300 bps.

- Compatible with V.22 bis at 2400 bps, V.22 and Bell 212 at 1200 bps, and Bell 103 modems at 300 bps, all auto selectable
- AT/Asynchronous auto dial
- V.25 bis Synchronous auto dial
- MNP error correction (Level 4)
- Terminal speed conversion
- Password protection on nine stored telephone numbers
- Full front panel switches and indicators
- Speaker for call progress monitoring
- FCC and DOC registered for direct connect to dial lines
- Codex 2239 dual modem card also available for 2000 Series nest (see page 46)
- Ask about our extended warranty or see page 57

TYPICAL APPLICATION

The Codex 2234 with MNP ensures that important payroll data from the branch office gets through under adverse line conditions.

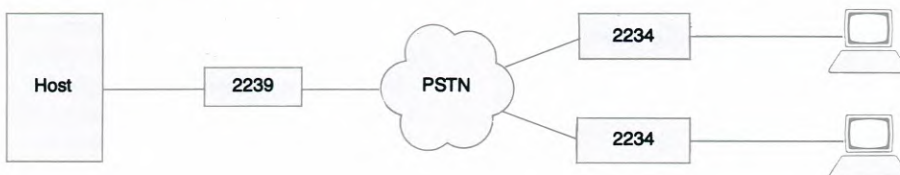

TO ORDER

#40234	2234 standalone data modem	
	Qty. 1-9	\$540
	10-19	\$520
	20+	GC
#40239	2239 dual modem card	
	Qty. 1-9	\$975
	10+	GC



Looking for an internal modem?
See page 53.

25% off
PC software
with
Codex 2234
purchase

(see page 11)

IN-STOCK PRODUCTS SHIPPED
IN 24 HOURS OR LESS!



**CODEX
2234**

SPECIFICATIONS

Modem Data Rates:

Synchronous: 2400 or 1200 bps

Asynchronous: 2400, 1200 or 300 bps.

Terminal Data Rates:

Asynchronous: 9600, 4800, 2400, 1200, 300 bps independent of modem data rate

Synchronous: equal to modem data rate

Allowable Data/Autocalling:

Codex AT Mode: Auto selects speed and parity for 10-bit ASCII commands.

Codex Terse Mode: User selectable synchronous; V.25 bis bit (SDLC/HDLC) or byte oriented mode, also IBM BSC mode, ASCII, or EBCDIC.

MNP: Service Class 3

Digital Interface: EIA 232-C

Modulation: 16-point QAM (2400 bps) or 4-point DPSK (1200 bps) or FSK (300 bps).

Transmitter Output Level: User selectable permissive (-9 dBm) or program (0 to -12 dBm).

Dial Modes: Pulse or tone dialing (auto select or user selectable). Midstream switching to tone dialing from pulse dialing during the same call (programmable).

Telephone Line Interface: USOC RJ11 voice jack or RJ45S program data jack.

Power Requirements: 115 Vac, 6W maximum, External wall mount transformer, UL/CSA certified.

Size: 2.25 in. (H) x 6.75 in. (W) x 9.5 in. (D); Wt. 1.3 lb. wall transformer, 1.7 lb. modem.

Certification:

FCC Registration Number:

AMQ95Q-10084-MD-E

Ringer Equivalence: 0.9B

DOC Registration Number: 725-1320A

DOC Load Number: 16

DIAL MODEMS



**CODEX
2264**

TO ORDER

#41700 2264 standalone	
Qty. 1-6.....	\$1,695
7+.....	GC
#41800 2264 card	
Qty. 1-6.....	\$1,525
7+.....	GC
#26304 19" rack shelf (fits 2 modems).....	\$150

Our new V.32 modem has MNP error correction—and is packed with more extras than ever before.

- 9600, 4800, 2400, and 1200 bps sync and async full-duplex operation over *two-wire dial* or *two- or four-wire leased lines*
- Full V.32 and V.22 bis compliant; also compatible with V.22 and Bell 212A; automatic connection at all speeds
- MNP Level 4 error correction
- Standard V.25 bis sync and async and AT auto-dial command sets with call progress monitoring and nine stored phone numbers
- Speed conversion allows DTE speed to remain fixed from 1200 to 19,200 bps while modem adapts speed to match remote modem or line quality under control of ARS
- Automatic, manual, and DTE initiated single line restoral (SLR) capability in leased line mode
- Adaptive Rate System (ARS) continuously adapts modem rate to optimize performance online
- Programmable modem straps via menu-driven, 16-character LCD front panel or attached DTE with four user-defined configurations stored in nonvolatile memory
- External modem control signalling for dial back security systems and external 801A/C auto dialers (Codex 2207)
- Standard internal eye pattern generator (EPG)
- Standalone and nest card versions available (see page 46 for Codex 2000 Series nest)

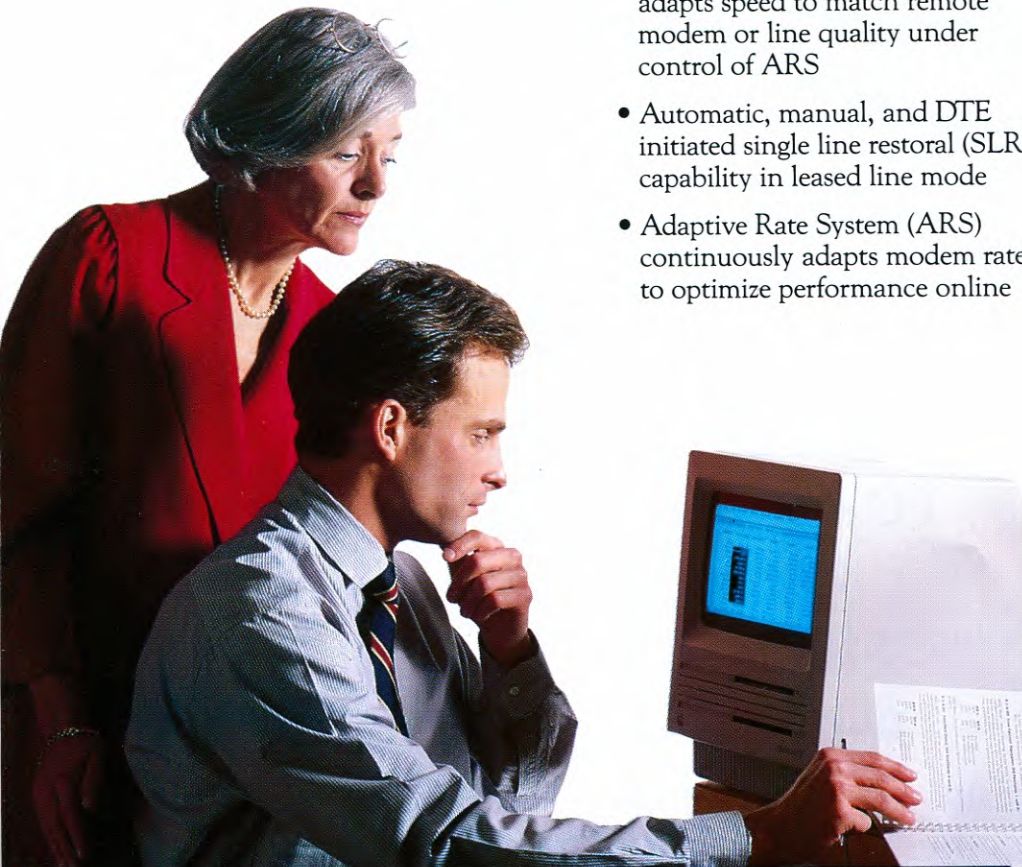

Codex Express product returns will be accepted within 30 days of shipment by calling 1-800-446-6336 for a Return Authorization Number (RMA). We will issue a full refund or credit promptly upon receipt of your return. No return will be accepted without an RMA number. We reserve the right to refuse returns after 30 days.

And it's the ideal choice for a variety of dial and leased line applications.

SPECIFICATIONS

Operation: Full-duplex or simulated half-duplex (CA/CF signalling) on two-wire dial or two- or four-wire leased lines.

Data Rates/Modulation: 9600 bps: V.32, 32-state TCM or 16-state QAM;
4800 bps: V.32, 4-state QAM;
2400 bps: V.22 bis, 16-state QAM;
1200 bps: V.22/Bell 212, 4-state QAM

Data Format: Sync: Serial by bit.
Async: Serial by bit: 8, 9, 10, or 11 bits.
Sync Data: V.25 bis bit (SDLC/HDLC) or byte oriented modes, ASCII or EBCDIC.

Error Correction: MNP™ Class 4

Operating Mode (dial line): Auto-dial, auto-redial, manual dial (through attached user telephone or 801 A/C auto-call unit). Auto answer.

Operating Mode (leased line): *Normal:* Two- or four-wire leased line operation.
Restoral: Automatic, manual, or DTE pin 14 or 20 initiated single line restoral. Automatic answering of dial line at remote modem upon failure of leased line.

Telephone Line Interface: RJ11/RJ 45 dial data jack, plus separate RM 8 leased line data jack.

Transmitter Output Level: *Dial:* permissive (-9 dBm fixed) or programmable. *Leased:* Selectable from 0 to -15 dBm in 1 dBm increments.

Power Requirements: 110/115 Vac, 35W maximum.

Certification: EMI/RFI FCC Part 15 Class A compliant.

Size: Height: 3.0 in. (7.62 cm)
Width: 8.5 in. (21.59 cm)
Depth: 16.0 in. (40.64 cm)
Weight: 5 lbs., 5 oz. (2.41 kg)

MNP is a registered trademark of Microcom, Inc.

TYPICAL APPLICATIONS

Off-Peak Polling or File Transfer (Point of Sale)

Let's assume your remote locations are polled at night, when dial rates are cheaper. By increasing your data rate with the Codex 2264 modem, you can dramatically shave communications time between headquarters and remote locations. It also means you can expand your system without purchasing another central site computer.

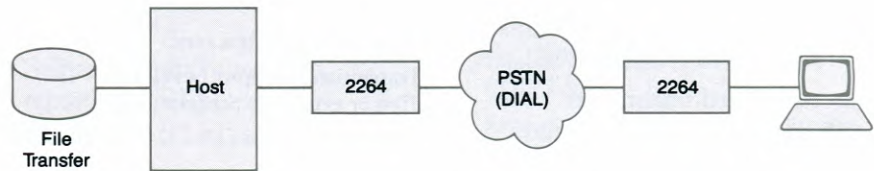

Leased Line with Automatic Single Line Restoral

What if your volume of traffic warrants a leased line circuit? And your application is so critical that you need a backup system should the leased line fail. The Codex 2264 performs both functions in a single modem. What's more, it can automatically detect a leased line failure and restore the circuit over a single dial line, cutting your backup expenses in half over traditional dual dial solutions.

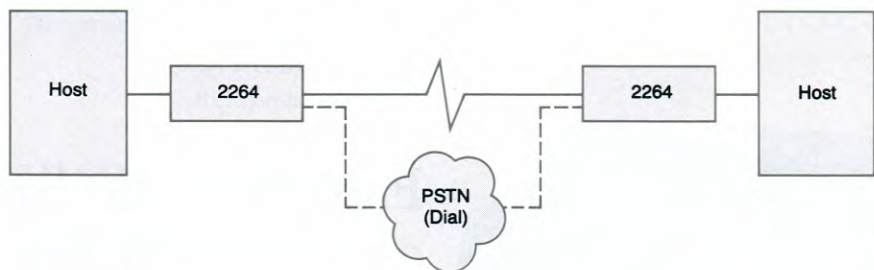

Digital Network Backup

Let's say you're running a digital network. What happens when the primary and redundant digital lines go down? Assuming that the backup required averages less than three hours a day, you should opt for an analog backup system that's able to handle high speeds: namely the Codex 2264 modem operating at 9600 bps. In addition to the advantage of high speed, dial is more cost-effective than leased lines when utilization is low. Also, the dial modem will backup only the line that has gone down—eliminating the need for a mirror image leased line analog system. Finally, dial lets you route around a site that is off-line without interruption to your network.

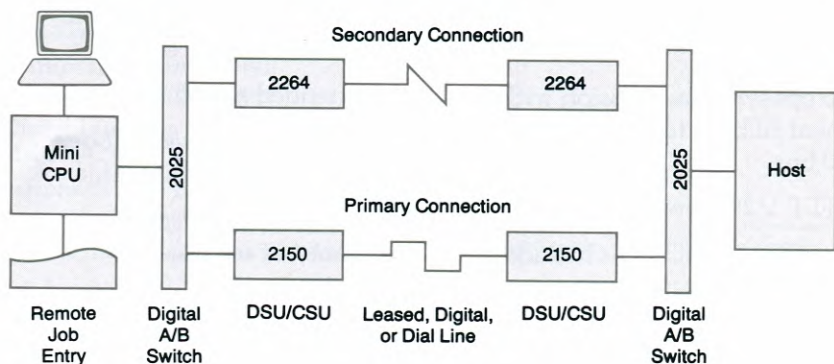

Reliable dial or leased line transmission at 4800 bps, fully compatible with Bell 208A/B.

- 4800 bps sync transmission
- Bell 208A/B-compatible
- Fully compatible with Codex 2207 Automatic Calling Unit
- Selectable fixed transmitter equalizers for poor group delay and amplitude line characteristics
- Automatic answer for unattended operation
- Anti-streaming detection
- Self-testing and condition reporting via front panel indicators

SPECIFICATIONS

Operation: Half-duplex over two-wire dial or leased line, full-duplex over four-wire leased line.

Data Rate: 4800 bps sync.

Transmitter Output Level: 0 to -12 dBm or externally programmed.

Digital Interface: EIA 232-C and CCITT V.24.

Telephone Line Interface: RJ45S, RJ11C or RJ16X.

Power Requirements: 115 Vac, 10W max.

Size: 7.0 in. (W) × 2.25 in. (H) × 9.6 in. (D); Wt. 2.6 lbs.

Certification: FCC rules, Part 68 and Part 15, Class A; UL, CSA, DOC.

FCC Registration No:
AK396F-15683-DM-N.

Ringer Equivalence: 1.1B.



**CODEX
2205**

TO ORDER

#25896	2205 standalone	
	Qty. 1-6	\$1,450
	7+	GC
#25959	2205 nest card	
	Qty. 1-7	\$1,340
	8+	GC
#25923	2200 nest (16 slots)	
	Qty. 1-9	\$700
#25925	Modem backplane	
	segment	\$22
#25926	ACU (2207) backplane	
	segment	\$50
#25927	Blank backplane	
	segment	\$11

Audio cables and product manual included.



**CODEX
2206**

TO ORDER

#25894	2206 standalone	
	Qty. 1-4	\$2,235
	5+	GC

Audio cables and product manual included.

- 9600 bps sync transmission with manual fallback to 7200 bps or 4800 bps
- CCITT V.29 compliant
- Leased line applications include point-to-point systems over four-wire conditioned or unconditioned lines
- Advanced microprocessor design

Flexible 9600 bps transmission over half-duplex dial or full-duplex leased lines.

- Automatic adaptive equalization compensates for changes in line distortion
- Built-in test functions including self-test, local analog, remote digital and remote loopback
- Unattended automatic answer
- Fully-compatible with Codex 2207 automatic calling unit
- Ask about our extended warranty or see page 57

Note: The 2206 is not recommended for multipoint applications. The 2206 is not Bell 208 compatible at 4800 bps.

SPECIFICATIONS

Operation: Half-duplex over two-wire dial or leased line, or full-duplex over four-wire leased line.

Data Rate: 9600, 7200, 4800 bps sync.

Digital Interface: Conforms to EIA-232-C and CCITT V.24.

Analog Interface: RJ11C or RJ45S.

Transmitter Output Level: 0 to -12 dBm programmable for leased lines. Direct connect modes are permissive (-9 dBm) or programmable.

Power Requirements: 115 Vac, 20W nominal.

Certification: FCC Rules, Part 68 and Part 15, Class A.

FCC Registration No:
AK396F-11677-DM-N.

Ringer Equivalence: 0.3B.

Size: 9.63 in. (W) × 3.13 in. (H) × 11.63 in. (D); Wt. 5.12 lbs.

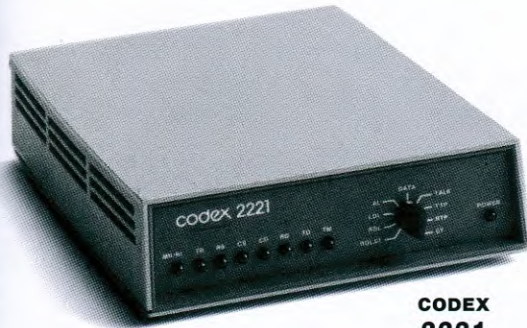

**CODEX
2221**

- Operates two-wire, half-duplex over dial or leased lines; full-duplex over four-wire leased lines
- 2400 bps async or sync transmission

TO ORDER

#25760	2221 standalone data modem	
	Qty. 1-9	\$765
	10-14	\$730
	15+	GC
#25960	2221 nest card	
	Qty. 1-9	\$655
	10-16	\$620
	17+	GC

Audio cables and product manual included with each unit.

Economical async or sync transmission at 2400 bps, fully compatible with Bell 201B/C.

- Compatible with Bell 201B and 201C modems
- Auto- or manual-answer, manual-call
- Self-testing and condition reporting via LED status indicators
- Advanced microprocessor design
- No line conditioning required
- Anti-streaming delay, strap-selectable
- Satellite delay option
- Compatible with Codex 2207 Automatic Calling Unit

SPECIFICATIONS

Modulation: Differentially Coherent Phase Shift Keyed (PSK).

Transmitter Level: 0 to -12 dBm programmable, permissive (-9 dBm).

Digital Interface: EIA232-C and CCITT V.24.

Line Current Disconnect Option: Selectable after 0, 8.5, 90 or 200 ms of loop interruption.

Telephone Interface: RJ45S or RJ11C.

Anti-Streaming Delay: 55 seconds.

Power: 115 Vac, 10W max.

Size: 7.0 in. (W) x 2.25 in. (H) x 9.6 in. (D); Wt. 2.6 lbs.

Certification: FCC rules, Part 68 certified, DOC, FCC Part 15, UL. *Registration No:* AK396F-67811-DM-E. *Ringer Equivalence:* 0.5B.

Advanced async transmission at 1200 bps, fully compatible with Bell 202S/T.

- Compatible with Bell 202S and 202T modems
- Compatible with Codex 2207 Automatic Calling Unit
- Auto-Answer, Manual Call
- Self-testing and condition reporting via LED status indicators
- EIA-232-C and CCITT V.24 compatible
- Advanced microprocessor design
- No line conditioning required
- Satellite delay option

SPECIFICATIONS

Operation: Two-wire half-duplex dial or leased lines; four-wire full-duplex leased lines.

Data Rate: 1200 bps asynchronous.

Modulation: Phase coherent Frequency Shift Keyed (FSK).

Transmitter Output Level: Programmable or Permissive.

Digital Interface: Conforms to EIA 232-C and CCITT V.24.

Telephone Line Interface: RJ45S, RJ11C.

Certification: FCC rules, Part 68 certified, DOC, FCC Part 15, UL, CSA.

Reg. No: AK39F-72226-DM-N. *Ringer Equivalence:* 0.3B.

Power: 115 Vac, 10W max.

Size: 2.25 in. (H) x 7.00 in. (W) x 9.60 in. (D); Wt. 2.0 lbs.



**CODEX
2219**

TO ORDER

#25754	2219 standalone	
	Qty. 1-9	\$530
	10-19	\$505
	20+	GC
#25954	2219 nest card	
	Qty. 1-9	\$420
	10-24	\$400
	25+	GC

Audio cables and product manual included.

Limited Distance Modems

LED indicators to monitor system status



Line interface

EIA-232-C data terminal connector

Power cord connector

Our short-haul modems pack more performance and speed into a new compact size.

We've improved on our family of limited distance modems with the Codex 2171 and 2172. In addition to a new streamlined design, these modems offer even more performance and features than their predecessors, the popular Codex 2121 and 2122.

Unlike conventional "line drivers" which do not modulate and demodulate data, the Codex

2100 Series limited distance modems convert and send your data at distances up to 26 miles and at speeds up to 80 kbps. They feature advance technology—such as Quadrature Diphase Modulation and Automatic Adaptive Equalization—that lets you send your data farther and with greater accuracy. And our average mean time between failure (MTBF) for these modems is an unequalled 200,000 hours in the field!

Codex short-haul modems let you use the miles of twisted-pair

wiring already installed in your facilities. So when you're ready to grow, you can simply add more wiring. Or you can lease a Local Area Data Channel and let the local Telco provide the transmission medium for you. Either way, your data arrives quickly and accurately, whether it's traveling across campus or across town.

Call us at 800-446-6336 and we'll explain why our limited distance modems are the best buy in the industry!

LIMITED DISTANCE MODEMS

More flexible than ever—our 19.2 kbps short-haul modem has integral async-to-sync conversion for distances up to 26 miles.



**CODEX
2171**

- Selectable synchronous data transmission rates from 1200 bps to 19.2 kbps, including 14.4 and 16.8 kbps as standard operating speeds
- Full-or half-duplex with four- or two-wire applications; constant or controlled carrier
- Internal async/sync conversion standard
- CCITT V.54 compliant
- Loaded line operation up to 4800 bps
- Operating distance up to 26 miles; point-to-point and multipoint
- Local and remote unattended diagnostic capability with internal test pattern generator
- Automatic adaptive equalization for unmatched data reliability
- Operating status and diagnostic indicators on front panel
- Signal-compatible with Codex 8250 and 2121

TYPICAL APPLICATION

The Codex 2171 LDM used with the Codex 6003 stat mux save lines in campus environments.

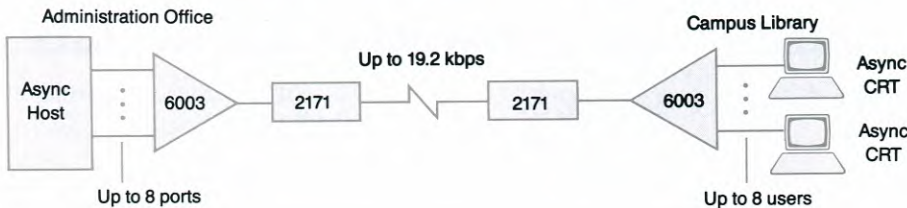

SPECIFICATIONS

Operation: Operates over unloaded, unconditioned telephone company local area data channels or private twisted pair cable; complies with AT&T Technical Reference 43401 for operation over Telco Local Area Data Channels.

Data Rates: 1200, 2400, 4800, 7200, 9600, 12,200, 14,400, 16,800, 19,200 bps (sync or async).

Modulation: Quadrature Diphase Modulation (QDM), Differential Diphase (Codex 8250-compatible).

Digital Interface: EIA232-C and CCITT V.24

Power Requirements: 115Vac, 6W typical (external transformer).

Transmitter Output Level: 0 dB or AT&T Pub 41028 or Pub 43401 conformance (FCC Part 68)

Size: 6.6 in. (W) x 1.1 in. (H) x 9.45 in. (D); Wt. 1.3 lbs (without external transformer)

Cables: Supplied with one modular-to-modular audio cable.

TO ORDER

#28400	2171 standalone	
	Qty. 1-3	\$695
	4-9	\$662
	10-15	\$632
	16+	GC
#28416	2171 card	
SEE BELOW	Qty. 1-3	\$560
	4-9	\$533
	10-19	\$509
#28425	2170 nest	
	Qty. 1-9	\$750
	10+	\$740
#28414	Modular-to-spade audio cable	\$10



**IN-STOCK PRODUCTS SHIPPED
IN 24 HOURS OR LESS!**

LIMITED DISTANCE MODEMS



**CODEX
2172**

- Point-to-point and multipoint operation
- Local and remote unattended diagnostic capability with internal test pattern generator eliminates requirement for external test equipment; CCITT V.54 compliant
- Automatic, adaptive equalization
- Receive Data Retiming Buffer for applications requiring external timing (e.g., digital networks such as DDS)
- Compact standalone or high density common nest versions available

Superior selectable sync transmission now from 32 to 80 kbps and up to 9 miles.

SPECIFICATIONS

Operation: Four-wire, half- or full-duplex; or two-wire, half-duplex.

Data Rates: 32, 48, 56, 64, 72, 80 kbps.

Modulation: Quadrature Diphas Modulation (QDM).

Digital Interface: 34-pin, M-block female connector; CCITT V.35.

Power Requirements: 115 Vac, 6W max. (external transformer).

Transmitter Output level: 0 dB or FCC Part 68 (AT&T Pub 41028 or Pub 43401 conformance).

Size: 6.6 in. (W) × 1.1 in. (H) × 9.45 in. (D); Wt. 1.3 lbs. (without external transformer).

Cables: Supplied with one modular-to-modular audio cable.

TO ORDER

#28408	2172 standalone	
	Qty. 1-3.....	\$730
	4-9.....	\$695
	10-15.....	\$664
	16+.....	GC
#28428	2172 card	
	Qty. 1-3.....	\$595
	4-9.....	\$567
	10-18.....	\$541
	19+.....	GC
#28431	V.35 adapter (required for #28428).....	\$60
#28414	Modular-to-spade audio cable.....	\$10



**CODEX
2111**

TO ORDER

#48150	2111 LDM standalone	
	Qty. 1-3.....	\$335
	4-9.....	\$310
	10+.....	\$295
#48165	2111 LDM card	
	Qty. 1-3.....	\$255
	4-9.....	\$235
	10+.....	\$225

Audio cables and product manual included.

See typical operating chart on page 22.

An economical solution for quality transmission of async data up to 23 miles.

- Distributes local async data at speeds up to 19.2 kbps; operates over loaded facilities at speeds up to 4800 bps
- Operates over private twisted pair cables or Telco Local Area Data Channels; complies with AT&T Tech. Ref. 43401. Also UL, CSA, FCC compliant.
- Unique high isolation design provides exceptional performance and noise immunity

SPECIFICATIONS

Operation: Full- or half-duplex, point-to-point or multipoint, switched or constant carrier.

Data Rates: 75 to 19,200 bps.

Data Format: 9, 10 or 11-bit asynchronous.

Line Equalization: Fixed, two-stage.

Transmitter Output Levels: -4, -11, -18, -25 dBm.

Digital Interface: EIA-232-C, CCITT V.24, or 20 mA current loop.

Power: 115 Vac, 4W typical.

Size: 8.5 in. (W) × 3.1 in. (H) × 9.0 in. (D); Wt. 4.8 lbs.

Looking for an economical solution for shorter distances?
See page 52.

Integrated network control allows monitoring device and line test from a central location.

- Codex's exclusive Quadrature Diphase Modulation provides improved performance, increased range and superior noise immunity
- Economical distribution of local synchronous data at speeds up to 19,200 bps. Standard product supports up to 4800 bps async data
- Async/sync conversion model available for use with async DTE equipment up to 19.2 kbps
- Local and remote unattended diagnostic capability, compliant with CCITT V.54
- 75 bps Independent Secondary Channel
- Automatic adaptive equalization
- Operation over loaded lines at 2400 bps
- Signal compatible with Codex 8200, 8250 and 2121 LDMs
- Common 2120 LDM nest
- Ask about our extended warranty or see page 57

SPECIFICATIONS

Operation: 4-wire, full-duplex for point-to-point or multipoint.

Data Rates: 2400 bps to 19.2 kbps.

Modulation: Quadrature Diphase Modulation (QDM), 8250-compatible (Diphase).

Digital Interface: EIA-232-C and CCITT V.24.

Power Requirements: 115 Vac, 10W typical.

Transmitter Output Levels: 0 dB or AT&T Automatic Bell Pub 41028 or Pub 43401 Conformance.

Size: 8.10 in. (W) × 3.50 in. (H) × 9.80 in. (D); Wt. 6.50 lbs.



Codex Express product returns will be accepted within 30 days of shipment by calling 1-800-446-6336 for a Return Authorization Number (RMA). We will issue a full refund or credit promptly upon receipt of your return. No return will be accepted without an RMA number. We reserve the right to refuse returns after 30 days.



**CODEX
2123**

TO ORDER

- #49354** 2123 LDM standalone with
async/sync conversion option
Qty. 1-8 \$1,250
9+ GC
- #49355** 2123C LDM dual card set
with async/sync conversion
option
Qty. 1-8 \$1,125
9+ GC
- #48160** 2120 LDM nest
Qty. 1-9 \$750
10+ \$740

Audio cables and product manual included.

**IN-STOCK PRODUCTS SHIPPED
IN 24 HOURS OR LESS!**

**CALL CODEX EXPRESS
800-446-6336**

LIMITED DISTANCE MODEMS

Codex LDMs: typical operating range in miles

2171 Asynchronous/Synchronous LDM				
Data Rate (bps)	AWG 19	AWG 22	AWG 24	AWG 26
1200*	26	18	14	11
2400	26	18	14	11
4800	24	16	12	10
7200	20	12	10	7.5
9600	19	12	9	7.5
12,000	17	10	8	6
14,400	15	9	6.6	5
16,800	13	7	5	4
19,200	13	7	5	4

*Differential Diphas Modulation. Constant Carrier/Quadrature Diphas Modulation 0 db or ATT PUB 41028

2111 Asynchronous LDM									
Data Rate (bps)	Maximum Transmitted Power Level Permitted by AT&T 43401	Unloaded Circuits (AWG)				Loaded Circuits*			
		AWG 19	AWG 22	AWG 24	AWG 26	AWG 19	AWG 22	AWG 24	AWG 26
2400	-4 dBm	23	15	12	9	24	16	13	10
4800	-11 dBm	22	13	10	7.5	23	15	12	9
9600	-18 dBm	18	10	8	6	0	0	0	0
19,200	-25 dBm	10	6	4	3	0	0	0	0

*When loaded facilities are used, circuit restrictions do not allow operation at speeds greater than 4800 bps.

2172 High-speed synchronous LDM			
Transmission Rate of 80 kbps*			
AWG 19	AWG 22	AWG 24	AWG 26
9.0 miles	5.5 miles	4.0 miles	3.0 miles

*Operating range at transmit rate of 40 kbps will be up to 10% longer.

2123 Synchronous LDM with network control				
Data Rate (bps)	AWG 19	AWG 22	AWG 24	AWG 26
2400	23	15	12	9
4800	17	12	8	6
7200	20	14	10	7.5
9600	19	12	9	7.5
12,000	17	10	8	6
14,400	15	9	6.6	5
16,800	13	7	5	4
19,200	13	7	5	4

Constant Carrier 0 db or ATT PUB 41028

NOTE: AWG = American Wire Gauge

TYPICAL SHORT-HAUL APPLICATION

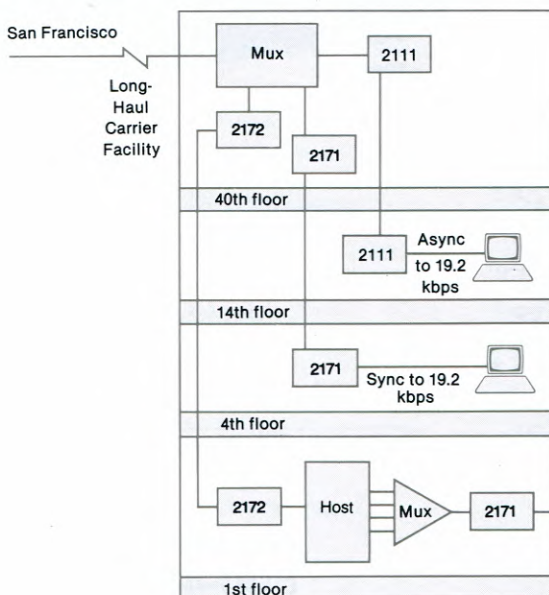

Our LDMs provide solutions in a variety of different applications. The results are unbeatable versatility and cost savings. The long-haul network of a financial services company based in New York City terminates at a multiplexer in their corporate headquarters. From there, Codex LDMs deliver a range of different, cost-effective solutions to meet specific short-haul needs. Some LDMs, running on company-installed twisted-pair wiring, transmit both sync and sync/async data to terminals and work stations on various floors. Other LDMs transmit data at 19.2 kbps to the company's field sales office in Newark, NJ, over a Telco-provided Local Area Data Channel.

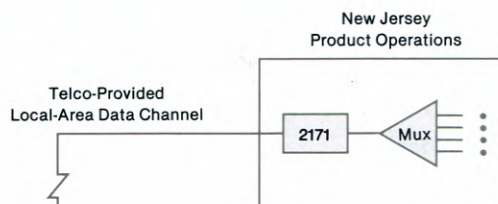

**CALL CODEx EXPRESS
800-446-6336**

Leased Line Modems

Attractive styling with no fan (convection-cooled)

Optional multiplexer card allows independent configuration of up to 4 channels at rates of 2400 bps each

CCITT and EIA indicators provide instant status information

EIA-232-C interface

Data rates of 9600/V.29, 7200 and 4800 bps at the touch of a button behind the fold down front panel

Leased line telephone hook-up

Leased line modems—packed with power and functionality for a wide variety of applications.

Reliability, performance, quality, breadth of line. Codex leased line modems offer all that and more—in point-to-point and multipoint applications.

The Codex 2320/2340, 2321/2341, and 2362 offer Codex-pioneered Quadrature Amplitude Modulation for superior performance over unconditioned leased lines. Plus, Automatic

Adaptive Equalizers to compensate for line distortions. Or select the Codex 2382, a truly cost-effective solution for critical, high-throughput solutions. For economy and speed, the 2382 delivers 19.2 kbps transmission without network control.

Codex Express also offers low- to high-speed leased line modems with built-in network control, for use with or without a Codex network management system. For basic networking applications, the Codex 2500

Series transmits at speeds from 2400 bps to 14.4 kbps and offers both multipoint and point-to-point models.

Our top-of-the line network-controlled 2600 Series modems offer speeds from 4800 bps to 19.2 kbps and a full range of options, including integral multiplexers modem sharing units, dual dial restoral, X.25 PADs, and data encryption.

Questions about our leased line options? Call 800-446-6336 and we'll connect you with the answers—and the modems you're looking for!

LEASED LINE MODEMS

Superior performance at an economical price in leased line point-to-point applications.



SPECIFICATIONS

Operation: Four-wire, point-to-point half- or full-duplex; or two-wire, point-to-point half-duplex.

Data Rate: 2320: 4800 or 2400 bps.
2340: 9600, 7200 or 4800 bps.

Modulation: Quadrature Amplitude Modulation (QAM).

Data Format: Full-duplex, synchronous or asynchronous transmission.

Circuit Requirements: 3002 unconditioned, leased line.

Line Equalization: Automatic adaptive.

Transmitter Output Level: Selectable 0 to -15 dBm.

Timing: Selectable internal, external or loopback.

Size: 8.5 in. (W) × 3.0 in. (H) × 16.0 in. (D); Wt. 5.3 lbs.

- CCITT V.29 compliant (2340 only)
- CCITT V.27 bis compliant (2320 only)
- Fallback speeds for maintaining operation over degraded lines
- VLSI design for compactness and reliability
- Low AC line power requirements; convection-cooled, no fan required
- Extensive fault isolation and performance status monitoring capabilities
- Optional four-channel buffered mux
- Flexible design featuring modem and multiplexer cards that are totally interchangeable with standalone and nest enclosures
- Internal Eye Pattern Generator (EPG) monitors audio line quality during modem operation
- Selectable synchronous or asynchronous operation
- Compatible with Codex 2010 dial back-up unit - see page 44
- One-year on-site warranty

TO ORDER

#26200	2320 standalone data modem	
	Qty. 1-6	\$1,595
	7+	GC
#26204	2320 standalone and four-channel multiplexer	
	Qty. 1-4	\$2,325
	5+	GC
#26210	2320 nest card	
III NEST PG. 46	Qty. 1-7	\$1,375
	8+	GC
#26212	2320 nest card with four-channel multiplexer	
III NEST PG. 46	Qty. 1-4	\$2,100
	5+	GC
#26220	2340 standalone	
	Qty. 1-6	\$1,650
	7+	GC
#26224	2340 standalone and four-channel multiplexer	
	Qty. 1-4	\$2,300
	5+	GC
#26230	2340 nest card modem	
III NEST PG. 46	Qty. 1-6	\$1,450
	7+	GC
#26232	2340 nest card with four-channel multiplexer	
III NEST PG. 46	Qty. 1-4	\$2,100
	5+	GC
#26280	4-channel field upgrade kit	
	Qty. 1	\$650
#26304	19" rack shelf (fits 2 modems)	
	Qty. 1	\$150

See page 46 for Codex 2000 Series enclosure for use with card versions.

TYPICAL APPLICATION

For async applications in expanding networks, use the Codex 2340 and Codex 6015 stat mux.

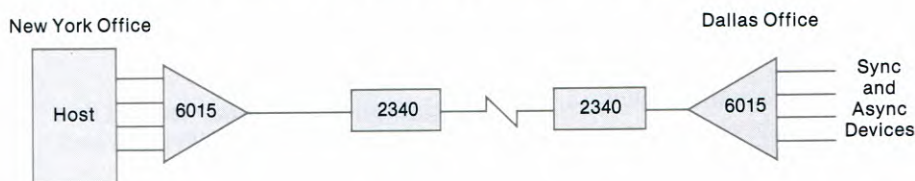



**CODEX
2321**



**CODEX
2341**

- VLSI design for compactness and reliability
- Low AC line power requirements; convection-cooled, no fan required
- Extensive fault isolation and performance status monitoring capabilities
- Flexible design featuring interchangeable standalone and nest cards

Economical multipoint and point-to-point data transmission at 4800/9600 bps.

- Master modem can test up to 33 addressable slave modems
- Train On Data (TOD) eliminates data-disruptive retrains in multipoint environments
- Fast polling—short training times (17 ms-2341; 9 ms-2321)
- CCITT V.29 compliant (2341 only)
- Standard asynchronous to synchronous conversion
- Configuration, testing and operating front panel controls
- Mixed inbound rates enable “slave” modems to transmit data at differing rates
- One-year on-site warranty

SPECIFICATIONS

Modulation: Quadrature Amplitude Modulation (QAM).

Data Format: Full-duplex, synchronous binary serial data.

Operation: Four-wire, point-to-point or multipoint, full-duplex.

Circuit Requirements: 3002 unconditioned, leased line.

Digital Interface: EIA 232-C/D and CCITT V.24.

Line Equalization: Automatic Adaptive.

Modem Data Rates:

2321: 4800 or 2400 bps.

2341: 9600, 7200 or 4800 bps.

Training Time:

2321: 253, 49, 9 ms.

2341: 253, 17 ms.

Transmitter Output Level: Selectable from 0 to -15 dBm.

Timing: Selectable internal, external or loopback.

Voltage Requirements: 115 Vac, 25W max.



Size: 8.5 in. (W) × 3.0 in. (H) × 16.0 in. (D); Wt. 6 lbs.

TYPICAL APPLICATION

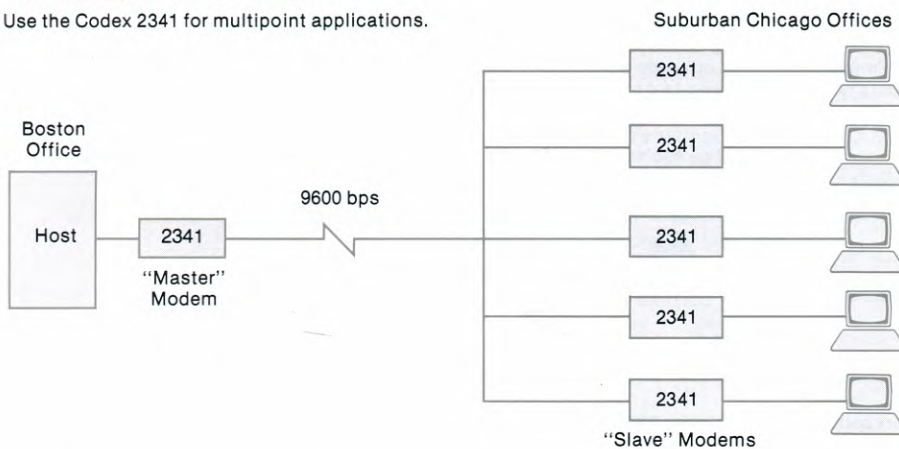
Use the Codex 2341 for multipoint applications.



TO ORDER

- #26240 2321, 4800 bps standalone
Qty. 1-5 \$1,680
6+ GC
- #26250 2321, 4800 bps nest card
 NEST PG. 46
Qty. 1-6 \$1,455
7+ GC
- #26260 2341, 9600 bps standalone
Qty. 1-5 \$1,950
6+ GC
- #26270 2341, 9600 bps nest card
 NEST PG. 46
Qty. 1-5 \$1,750
6+ GC
- #26304 19" rack shelf (fits 2 modems)
Qty. 1 \$150

Audio cables and product manual included.

See page 46 for Codex 2000 Series nest enclosure. For use with card versions.



**CALL CODEX EXPRESS
800-446-6336**

LEASED LINE MODEMS



A superior, high-speed data modem for point-to-point transmission up to 14.4 kbps.

TO ORDER

		CODEX 2362
#26345	2362 standalone point-to-point one channel	
	Qty. 1-3	\$2,740
	4+	GC
#26346	2362 standalone point-to-point with four-channel mux	
	Qty. 1-2	\$3,425
	3+	GC
#26347	2362 standalone point-to-point with six-channel mux	
	Qty. 1-2	\$3,665
	3+	GC
#26348	2362 14,400 bps point-to-point card	
 NEST PG. 46	Qty. 1-3	\$2,420
	4+	GC
#26349	2362 14,400 bps point-to-point card with four-channel mux	
 NEST PG. 46	Qty. 1-2	\$3,105
	3+	GC
#26350	2362 14,400 bps point-to-point card with six-channel mux	
 NEST PG. 46	Qty. 1-2	\$3,335
	3+	GC
#26304	19" rack shelf (fits 2 modems)	
	Qty. 1	\$150

See page 46 for Codex 2000 Series enclosure for use with card versions.

- Point-to-point data transmission at speeds from 4.8 to 14.4 kbps
- 8-state trellis coded modulation, CCITT V.33 compliant
- CCITT V.29 compliant
- Push button front panel
- Sixteen character alphanumeric display
- Optional four- or six-channel time division multiplexer (TDM)
- Internal asynchronous to synchronous conversion
- Internal eye pattern generator (EPG)
- MTBF - 30,000 plus hours
- Available in standalone or nest card configuration
- One-year on-site warranty standard. Ask about our extended warranty or see page 57

SPECIFICATIONS

Analog Interface: The Codex 2362 modem is capable of operation over standard Bell 3002 D1 four-wire, leased lines.

Digital Interface: The 25 pin interface connector meets the specification of EIA-232-C/D and CCITT V.24/V.28.

Main Channel Modulation Technique: Trellis coded modulation, V.33 compatible Quadrature amplitude modulation, V.29 compatible.

Data Format: Synchronous; asynchronous 6, 7, 8, 9 data bits.

Data Rates: CCITT V.33 14.4, 12.0 kbps at 2400 baud. CCITT V.29 9600, 7200, and 4800 bps at 2400 baud.

Transmitter Output Level: Selectable from 0 to -15 dBm in 1 dBm increments.

Timing: Internal, external (any port), or receiver loopback.

Power Requirements: 115 Vac, 48 to 63 Hz, 22 watts consumption (excluding options).

Size: 8.5 in. (W) x 3 in. (H) x 16 in. (D); Wt. 6.9 lbs., with multiplexer 7.7 lbs.

TYPICAL APPLICATIONS

The Codex 2362 with an integral 6-channel time-division mux (TDM) allows up to six devices to share one high-speed line (as long as the sum of their data rates don't exceed 14.4 kbps).

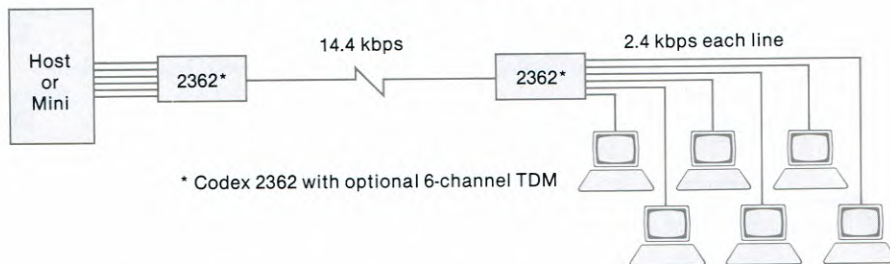

Achieve greater throughput and bandwidth between network ports by using the Codex 2362 standalone modems with the Codex 6003 and 6015 statistical multiplexers.

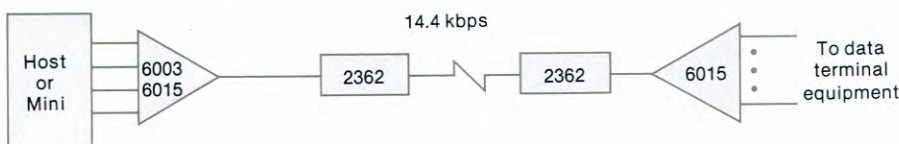

**CALL CODEX EXPRESS
800-446-6336**



**CODEX
2382**

SPECIFICATIONS

Analog Interface: The Codex 2382 in either PP-19.2 or V.33 mode is capable of operation over a standard M1020 or 3002 D1 4-wire leased line. The audio interface presents a 600 ohm impedance level.

Digital Interface: The 25-pin interface connector meets the specifications of both CCITT V.24/V.28 and EIA-232-C.

Main Channel Modulation Type: 64-state, 8-dimensional Trellis Coded Modulation for 19.2 kbps operation or 8-state, 2-dimensional TCM for V.33.

Data Format: Synchronous, serial, by bit.

Data Rate: Selectable 19.2 to 12.0 kbps in 2.4 kbps increments.

Transmitter Output Level: Selectable outputs from 0 to -15 dBm in 1 dBm steps.

Transmitter Timing: Selectable internal, external or loopback.

Receiver:

Dynamic Range: -6 dBm to -43 dBm.

Power Requirements:

90-127 VAC, 47 to 63 Hz, 55 watts maximum.

Environment: *Operating Temperature:* 32° to 122°F (0° to 50°C).

Storage Temperature: -40° to 158° (-40° to 70°C)

Relative Humidity: 5% to 95% (noncondensing)

Size: 3.5 in. (H) x 17 in. (W) x 16.25 in. (D);
Wt. 20 lbs.

A powerful, 19.2 kbps non-network control modem for optimum throughput.

- Point-to-point 12.0 kbps to 19.2 kbps
- Trellis Coded Modulation 64-state, 8-dimensional V.33 compliant
- Enhanced control panel to configure, monitor and test local and remote modems
- Error probability display for single read out of line quality
- Integral asynchronous to synchronous conversion
- Internal eye pattern generator
- Power-up self test
- Password protection
- Two-channel multiplexer—standard
- Options:
Four- or six-channel multiplexer
Dual dial restoral
Enhanced dual dial restoral
- MTBF - 30,000 hours
- One-year on-site warranty

TYPICAL APPLICATION

The Codex 2382 multiplexes data from four terminals, sending it to the CPU and minicomputer via a Codex 2320 tail circuit.

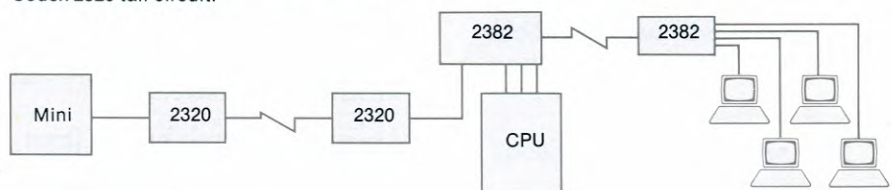

TO ORDER

Automatic Gold Club pricing for two or more! Call for details.

- #32581 2382 standalone point-to-point two-channel
- #32584 2382 standalone point-to-point with four-channel mux
- #32586 2382 standalone point-to-point with six-channel mux

Ask about our optional Dual Dial Restoral (DDR) and enhanced DDR cards.



Codex Express product returns will be accepted within 30 days of shipment by calling 1-800-446-6336 for a Return Authorization Number (RMA). We will issue a full refund or credit promptly upon receipt of your return. No return will be accepted without an RMA number. We reserve the right to refuse returns after 30 days.

**CALL CODEX EXPRESS
800-446-6336**

**IN-STOCK PRODUCTS SHIPPED
IN 24 HOURS OR LESS!**

LEASED LINE MODEMS



NEW! **CODEX 2510**

TO ORDER

- #25600 2510 standalone with network control
Qty. 1-6 \$1,450
7+ GC
- #26505 2510 nest card with network control
NEST PG. 46
Qty. 1-7 \$1,330
8+ GC
- #26304 Modem Shelf-holds 2 units per shelf
Qty. 1 \$150



Codex Express product returns will be accepted within 30 days of shipment by calling 1-800-446-6336 for a Return Authorization Number (RMA). We will issue a full refund or credit promptly upon receipt of your return. No return will be accepted without an RMA number. We reserve the right to refuse returns after 30 days.

Flexible, compact, economical network control plus 2400 and 1200 bps point-to-point or multipoint data transmission.

- Point-to-point and multipoint transmission at rates of 2400 and 1200 bps
- CCITT V.26 and Bell 201-compliant
- Operates with Codex Integrated Network Management Systems
- Provides reliable data communications over 3002 unconditioned leased lines using sophisticated signal processing technology
- Low error rate of less than one in one million bits
- Internal asynchronous to synchronous conversion
- User-friendly push-button front panel with 16-character alphanumeric display allows easy configuration
- Includes four loopback (V.54 compatible) and two test modes plus comprehensive self-test upon modem power up
- Flexible design, available as standalone or nest card version
- Substantially increase throughput in polling environments with Train On Data feature
- AQ status showing relative line quality, is continuously displayed and updated with no interruption of transmission

SPECIFICATIONS

Operation: 4-wire point-to-point or multipoint, full- or half-duplex or 2-wire half duplex.

Main Channel Modulation Technique: DPSK, CCITT V.26A/B and Bell 201 B compatible.

Data Rates: 2400 or 1200 bps.

Data Format: Synchronous/asynchronous 5,6,7,8, data bits.

Transmitter Output level: Selectable from 0 to -15 dBm in 1 dBm increments.

Timing: Internal, external, or receive data clock.

Network Control Channel: 75 bps, FSK modulation.

Digital: The 25-pin connector meets specifications of EIA 232-D.

Analog: The Codex 2510 modem is capable of operation over standard Bell 3002 unconditioned 2- or 4-wire leased lines.

Size: 8.5 in. (W) × 3 in. (H) × 16 in. (D).
Wt. 6 lbs.

EMI/RFI Susceptibility: FCC Part 15-Class A.

NETWORK CONTROL MODEMS

Codex 2500 Series and 2600 Series network control modems are available through Codex Express! Check out the Codex 2500 Series for basic applications. . .or turn the page for details on the top-of-the-line Codex 2600 Series with advanced features and functionality.



Codex 2500 Series modems are a great leased line value.

With standard features you'd find only as expensive options on other vendors' high-speed modems, these "workhorses" deliver the throughput and reliability your applications demand—all at prices you'll like!

The Codex 2520 and 2540. At 4800 and 9600 bps, respectively, these modems support both point-to-point and multipoint operating modes. The 2540 also features a mixed inbound rate (MIR) capability, allowing a remote site to transmit at maximum speed even when line quality degrades at other sites.

The Codex 2560. This model transmits at speeds up to 14.4 kbps in point-to-point

applications. Plus, it supports both V.33 and V.29 operation, which means a single modem can provide full data rate support for point-to-point 4800 bps to 14.4 kbps operation!

Advanced features add control and flexibility...and make these modems easy to use.

The Codex 2500 Series comes with built-in network control for management from central-site via a Codex network management system.

Plus, you get internal async/sync conversion for flexibility across applications. And

a menu-driven front panel that makes it easy to configure, test, and monitor devices.

Nest card versions can be used in a space-saving Codex 2000 Series Nest (see page 46) or in a Codex 6015 enclosure (offered on page 36), to give you a powerful—yet economical—mux/modem solution!

Need help deciding? Call the Codex Sales Office nearest you (see listing on page 58)—or call Codex Express at 800-446-6336 and ask for the Helpline!

Choose the model with the right speed and features for you!

Primary Data Rates	Codex 2500 Series	Codex 2600 Series
19.2 kbps	N/A	2680
16.8 kbps	N/A	2660
14.4 kbps	2560	2660
High-speed multipoint	N/A	2650
9600 bps	2540	2640
Dual multipoint	N/A	2630
4800 bps	2520	2620

Features	Codex 2500 Series	Codex 2600 Series
Network control	✓	✓
Async/sync conversion	✓	✓
Eye pattern generator	✓	✓
Soft strapping	✓	✓
Multiplexer options	✓	✓
Available as nest card	✓	✓
Dial restoration option	✓ (external)	✓ (internal)
Adaptive rate system	N/A	✓
Remote front panel	N/A	✓
Modem sharing unit	N/A	✓
Encryption option	N/A	✓
X.25 PAD option	N/A	✓
CTE option	N/A	✓
Field upgrades	N/A	✓

N/A: Not available with the Codex 2500 Series.

NETWORK CONTROL MODEMS

The Codex 2600 Series . . . our top-of-the-line network control modems. At speeds up to 19.2 kbps, these modems meet your toughest performance requirements today and accommodate new resources and applications when you're ready to add them.

**The Codex 2680.
Unmatched performance
and reliability at 19.2 kbps.**

Dramatically cuts your line costs by consolidating data from two 9.6 kbps lines onto one 19.2 kbps circuit. Standard features such as an integral two-channel multiplexer, adaptive rate system, and three Trellis Coded Modulation (TCM) schemes to maximize throughput when line conditions vary. . . all make sure your data arrives intact. High-speed reliability—along with a reputation for high performance that's unsurpassed in the industry—make the Codex 2680 today's leading 19.2 kbps modem.

**The Codex 2660.
Maximum throughput and
efficiency at 16.8 kbps.**

The world's first 16.8 kbps modem to use 8-state 2-dimensional Trellis Coded Modulation (TCM) for increased data reliability. Built-in

Adaptive Rate System (ARS) maximizes data throughput—even under varying line conditions—without operator intervention. And an integral multiplexer option with Modem Sharing Unit (MSU) lets you expand your network cost-effectively.

**The Codex 2650. 14.4 kbps
in the outbound direction . . .
for improved response times.**

Mixed Inbound Rate (MIR) feature maintains maximum network throughput when line conditions on only one drop have degraded—ensuring your multipoint network operates at peak efficiency. Provides a transaction rate increase of up to 48% over conventional 9600 bps multipoint modems and achieves 99.9% error-free outbound transmission at 14.4 kbps with TCM technology. So as the network grows, the Codex 2650 allows you to maintain response time without the expense of leasing additional lines.

**The Codex 2640 and 2620.
Maximum flexibility at
9600 bps and 4800 bps in
both point-to-point and
multipoint applications.**

The Codex 2640 features Codex-Improved (CI96) modulation for reliable transmission and Mixed Inbound Rates (MIR) to ensure that poor conditions on one line don't reduce the efficiency of the entire multipoint network. An integral multiplexer option with Modem Sharing Unit (MSU) lets you expand your network cost-effectively.

**The Codex 2630. Cut your
line costs by letting two
applications share a single
unconditioned line.**

Essentially two multipoint modems in one, the Codex 2630 provides an outbound aggregate speed of 9600 bps, with inbound data rates of 4800 and 2400 bps on two independent channels. Eliminates parallel lines for more cost-effective performance. Two integral Modem Sharing Units (MSUs) double the expansion capabilities for your network by letting additional terminals share channels at each modem location. . . . or by letting a single Codex 2630 support multiple hosts.



**CALL CODEX EXPRESS
800-446-6336**

NETWORK CONTROL MODEMS

Codex 2600 Series modems are also available in convenient, space-saving nest card versions.

We offer all models (except the Codex 2680) as modem cards for insertion in a Codex 2608 8-modem nest. The 19" rack-mountable nest saves space and allows you to interchange modem, option, and upgrade cards quickly and easily. You can install the nest cards yourself. . . or arrange for a Codex Customer Service representative to do it for you.

You can also order these options to enhance and improve the efficiency of your Codex 2600 network!

Enhanced Dual Dial Restoral (EDDR) provides complete network backup by allowing your Codex 2600 modem to *automatically* switch over to a full-duplex dial connection when necessary, periodically sample leased line quality, and terminate the dial connections when leased line conditions improve. **Manual Dual Dial Restoral (DDR)** option also available, with restoral triggered from modem front panel or Codex network management.

Integral Multiplexer/MSU eliminates parallel lines, helping to

streamline the network and reduce your overall networking costs. Available in 4-channel (for 2680*, 2660, 2640 and 2620) or 6-channel (for 2680* and 2660) versions which function as mux or MSU depending on specific application.

*No MSU on 2680

Integral X.25 PAD (Packet Assembler/Disassembler) provides multivendor support in private point-to-point networks, eliminating the need for a standalone async-to-X.25 converter. Available in 4- or 8-port versions, the X.25 PAD concentrates data from multiple remote async devices, reducing central-site computer port expenses. Mixed protocol environments can benefit from increased savings by configuring up to two points for TDM operation.

Encryption Card is designed to protect sensitive data while it's being transmitted— without adversely affecting response times or throughput. Installed in your 2600 Series modem*, each card can secure up to six terminals. . . for more economical protection than with standalone devices. Employs the Data

Order Encryption Option before September 1, 1989 . . . and receive two cards for the price of one! Call 800-446-6336 for details!

Encryption Standard (DES) algorithm approved by the National Bureau of Standards . . . the most trusted and widely used encryption algorithm for commercial applications. And if you order this option before September 1, 1989 for immediate

delivery, you'll get two encryption cards for the price of one! (while quantities last).

*For use only with modems used in the United States.
Encryption card not an option with Codex 2630.

Upgrade to faster speeds quickly and easily with these economical cards. . . shipped fast from Codex Express!

Upgrade an existing 2620 to a 2640, or a 2640 to a 2680 (with or without Enhanced Dual Dial Restoral). As with all other in-stock Codex Express products, we'll ship within 24 hours. The program includes installation by a Codex customer service representative. So call 800-446-6336 today to order these fast-ship upgrade cards. . . or ask for more information about upgrading your Codex 2600 Series modems to other speeds.

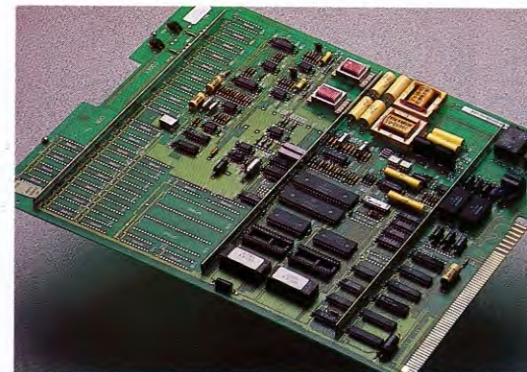

Call 800-446-6336 today to learn more about the Codex 2600 Series "Quick-Ship" program!

Digital Service Products

New Codex Data Service/Channel Service Units for flexible cost-effective management of your digital network.

Codex now gives you reliable large-system networking with our new 2150 and 2160 integrated Data Service/Channel Service Units (DSU/CSU).

A 2150/2160 interface between your system and digital links delivers the 99.5% data accuracy associated with high-performance DDS transmission.

Codex network control, asynchronous/synchronous

transmission and unattended remote testing are standard features of the Codex 2150/2160. Plus, the 2160 supports an optional 6-channel integral multiplexer making it a cost-effective alternative to a small digital multiplexer. Use these field-proven DSU/CSU units as an economical alternative to modems.

For non-networking applications, choose the Codex 2131 with data rates up to 9600 bps or the 2132 for higher speeds up to 56 kbps. Both are fully Bell-

compatible and include front panel indicators for instant system status.

To back up your high-speed digital circuits or for disaster recovery applications, use the Codex 2020 Switched 56 Data Unit. The 2020 combines DSU/CSU functionality and auto-dial capability in one package.

How can Codex DSU/CSUs ensure such reliable, productive communications? Call our specialists at 800-446-6336 and find out how we can do it for you!

Optional 6-Channel Time Division Multiplexer functions as inexpensive digital mux

EIA indicators provide instant status information

User-friendly configuration via 16-character alphanumeric display behind drop-down front panel

CCITT V.35 interface

Non-interruptive network management via unique derived secondary channel

Modular interface to DDS service



DIGITAL SERVICE PRODUCTS

New Codex network-controlled 2150 or 2160 DSU/CSU for point-to-point and multipoint digital service applications.

- Both 2150 and 2160 integrate DSU/CSU functionality to eliminate need for separate standalone units
- Designed for direct connection to the DATAPHONE™ Digital Service Network
- 2150 supports data rates of 2400, 4800 and 9600 bps. 2160 supports a data rate of 56 kbps either in point-to-point or multipoint operation
- Operates under Codex Integrated Network Management Systems (non-interruptive in the 2160 using a unique derived secondary channel)
- Integral asynchronous to synchronous conversion eliminates need for external converter boxes
- 16-character liquid crystal display for user-friendly access to soft straps (same functions also facilitated from network management console)
- Auto streaming terminal disconnect and analog tail circuit timing buffer are standard features
- Unattended remote testing either in point-to-point or multipoint operation

- 2150 provides EIA 232-D compatibility. 2160 provides CCITT V.35 compatibility
- 6-channel time division multiplexer option (2160 only)
- Available in standalone models or 16-card central site Codex 2000 Series nest assembly

DATAPHONE™ is a registered trademark of Dataphone Digital Service, Inc.

SPECIFICATIONS

Operation: Point-to-point or multipoint; 4-wire termination of DATAPHONE Digital Service (DDS).

Data Rates: 2150 provides operation at 2400, 4800 and 9600 bps. 2160 provides operation at 56 kbps.

Data Format: Asynchronous or synchronous.

Modulation: Bipolar return to zero, Alternate Mark Inversion.

Customer Interface: 2150: EIA 232-D; 2160: CCITT V.35 (Adapter Cable required).

Line Interface: RJ28 modular on product. Appropriate cable provided at no charge under a separate product code.

Size: 3 in. (H) × 8.5 in. (W) × 16 in. (D).



CODEX 2160

CODEX 2150 NEW!

TO ORDER

- #48517 2150 DSU/CSU standalone
 - Qty. 1-3 \$1,050
 - 4-9 \$950
 - 10+ \$895
- #48518 2150 card version of integrated DSU/CSU unit
 - NEST PG. 46
 - Qty. 1-3 \$950
 - 4-9 \$850
 - 10+ \$795
- #48519 2160 DSU/CSU standalone
 - Qty. 1-3 \$1,250
 - 4-9 \$1,150
 - 10+ \$1,095
- #48520 2160 card version of integrated DSU/CSU unit
 - NEST PG. 46
 - Qty. 1-3 \$1,150
 - 4-9 \$1,050
 - 10+ \$995
- #48521 2160 with 6-channel time division multiplexer, standalone
 - Qty. 1-3 \$2,495
 - 4+ GC
- #48522 2160 with 6-channel time division multiplexer, card version
 - NEST PG. 46
 - Qty. 1-3 \$2,295
 - 4+ GC
- #48523 V.35 Adapter Cable required with 2160 (PC 48519 and 48520)
 - Qty. 1 \$100
- #77969 2150/60 to RJ11 DDS wall jack (6 ft.). No charge when ordered with 2150/60
- #48603 2150/60 to RJ48 DDS wall jack (6 ft.). No charge when ordered with 2150/60
- #48600 2150/60 to 4-wire spade lug (6 ft.) No charge when ordered with 2150/60

DIGITAL SERVICE SERIES



**CODEX
2132**

TO ORDER

- #48507 2131 DSU/CSU standalone
Qty. 1-9 \$700
10-15 \$650
16+ GC
- #48508 2131C nest card
SEE BELOW
Qty. 1-9 \$680
10-15 \$630
16+ GC
- #48503 2132 DSU/CSU standalone
Qty. 1-9 \$950
10-11 \$895
12+ GC
- #48504 2132C nest card
SEE BELOW
Qty. 1-9 \$895
10-11 \$850
12+ GC
- #48506 EIA 232-C to V.35 Cable.
Required for operation with
2132C card version (#48504),
(5 ft.)
Qty. 1 \$55
- #48505 2130 nest assembly (includes
AC power module)
Qty. 1+ \$900



**CODEX
2020**

TO ORDER

- #48532 2020 Switched 56 Data Unit,
standalone
Qty. 1-3 \$1,695
4-6 \$1,595
7+ GC
- #66170 V.35 DTE cable, male to
male, 15 ft.
Qty. 1 \$60

- Ideal where leased DATAPHONE™ Digital Service (DDS) is not economical

Integrated DSU/CSUs provides efficient, economical performance for digital service applications.

- 2131 and 2132 integrated DSU/CSUs eliminate need for separate standalone models
- Internal test pattern generator eliminates need for external test equipment
- Color-coded status indicators for instant diagnostics of system performance
- Remote terminal (DTE) and (DDS) loopbacks
- Available in nested version. 2130 nest supports any combination of sixteen 2131 or 2132 units

SPECIFICATIONS

Operation: Point-to-point or multipoint, four-wire termination to DATAPHONE Digital Service (DDS).

Data Rates: 2131: 2.4, 4.8, 9.6 or 19.2 kbps, switch selectable.
2132: 56 kbps.

Data Format: Serial binary synchronous data in full-duplex, half-duplex, or simplex operation.

Modulation: Bipolar return to zero, 50% duty pulses.

Customer Interfaces:

Model 2131: EIA 232-C.

Model 2132: CCITT V.35.

Model 2132 nest card: 25-pin female DB25 connector. EIA 232-C to V.35 connector cable required.

Line Interface: (DDS Service) *Interface termination:* four-wire termination on rear panel terminal block.

Standalone Size: 9.75 in. (W) × 2.75 in. (H) × 12.75 in. (D); Wt. 5 lbs.

2130 Nest Size: 19.0 in. (W) × 12.25 in. (H) × 3.50 in. (D); Wt. 25 lbs.

Use the Codex 2020 with ACCUNET™ for high-speed switched digital dial backups or disaster recovery applications.

- 2020 combines DSU/CSU and Auto Dial capability in a compact package
- Integral Auto Dialer is EIA 232 serial and RS-366 parallel compatible
- 7 LED indicators and 7-position rotary switch on front panel for ease of use
- Dialer disables for operation as DDS compatible DSU/CSU
- Full diagnostic test functionality

SPECIFICATIONS

Data Rate: 56 kbps

Data Format: Serial binary, synchronous.

Data Encoding: Bi-polar, return-to-zero, per AT&T publication 62310.

Line Type: ACCUNET* Switched 56 Network.

DTE Interface: CCITT V.35.

Auto Dialer Data Rates: Auto selected to 1200, 2400 or 9600 bps.

Auto Dialer Interface: EIA 232 serial or RS 366 parallel.

Size: 9.76 in. (W) × 2.42 in. (H) × 10.81 in. (D); Wt. 5 lbs.

ACCUNET is a registered trademark of AT&T.

Multiplexers

Boost efficiency and reduce costs with powerful Codex multiplexing

Behind the economical multiplexing products found in this Codex Express catalog is a tradition of industry leadership in large-system networking technologies. Much of the R&D innovation in our larger multiplexing systems has been brought forward to our low-cost Codex 6000 Series of statistical multiplexers. Which explains how we've packed so much

functionality into such an affordable family of muxes. For example...the Codex 6015 supports virtually all brands of minicomputers...and delivers data concentration for up to 16 terminals over a single, high-speed link. And for entry-level users, the Codex 6003 combines up to eight channels and comes standard with factory-set defaults so all you need to do is "fine-tune" the parameters to match your needs.

The Codex 6216 and 6228 are the only medium-speed digital muxes on the market today that

let you configure, change, and diagnose your digital link without extra hardware. It's all done from your ASCII control terminal. With the highest functionality of any time-division muxes in this price range, the Codex 6216 and 6228 let you store up to four separate network configurations in memory—plus you can automatically re-route channel data without disrupting other active channels!

Each of our muxes offers special capabilities. Which best suits your needs? Call us at 800-446-6336 and let's find out!

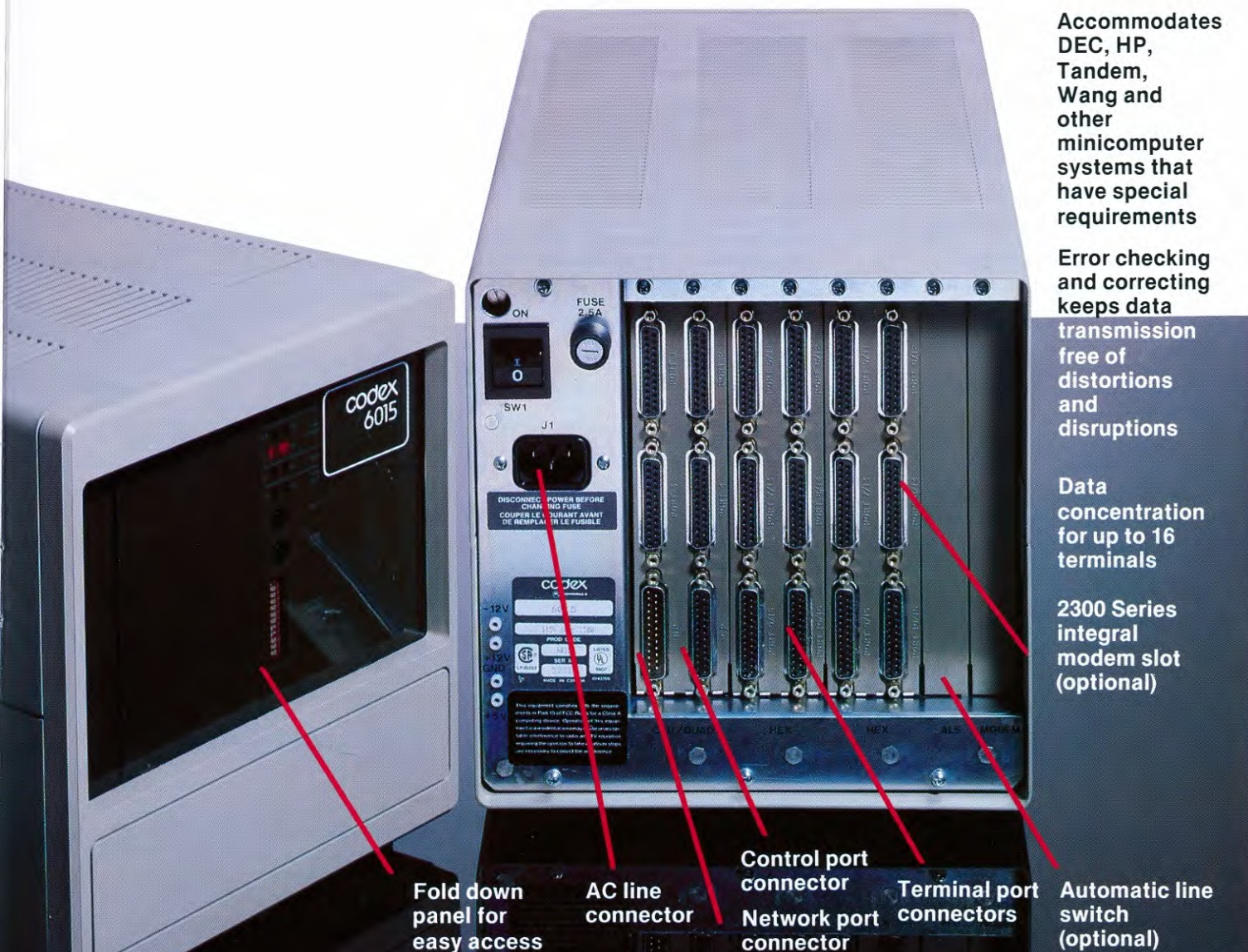

Accommodates DEC, HP, Tandem, Wang and other minicomputer systems that have special requirements

Error checking and correcting keeps data transmission free of distortions and disruptions

Data concentration for up to 16 terminals

2300 Series integral modem slot (optional)

Fold down panel for easy access

AC line connector

Control port connector
Network port connector

Terminal port connectors

Automatic line switch (optional)

MULTIPLIXERS

MULTIPLEXERS

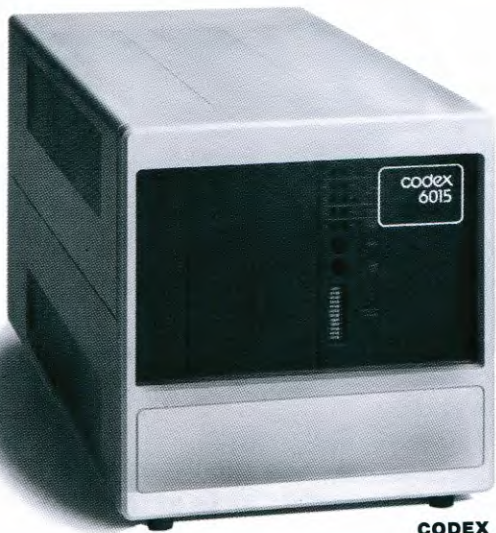

**CODEX
6015**

- Automatic line switch (ALS) option provides leased-line redundancy in the event of a primary leased-line failure
- Compatible with the Codex 6000 and 6700 Series products*
- Codex 2300 Series integral modems optional
- Provides data concentration for up to 16 terminals over single, high-speed composite link, up to 19.2 kbps

Economical multiplexing for virtually all minicomputers with both sync and async traffic.

- Port switching with contention and queuing maximizes computer port resources by eliminating the need for dedicated end-to-end connections
- Hunt groups provide local port selection, or port selection on a Codex 6015 located at the end of the communications link
- Multiprotocol Software Option (MSO) supports the following synchronous protocols:
 Burroughs 771 IBM BSC
 Burroughs Poll-Select ICL 7021, 7180, C02/C03
 CDC User 200 ISO R1745
 DEC DDCMP SITA P1024A
 Honeywell 701 Uniscope 100/200/400*
 Honeywell VIP 7700 Univac 1004
 (with Remote Line Univac DCT 2000
 Printer Option) Univac NTR 2R2

*Available from your local Direct Sales Office (see page 58).

SPECIFICATIONS

Power Requirement: 90 to 130 Vac;
150 W max.

Size: 8.6 in. (W) × 9.2 in. (H) ×
17 in. (D); Wt. 25 lbs.

TO ORDER

- #60150** 6015, 115V basic system (includes four terminal port connections)
Qty. 1 **\$1,500**
- #60153** Async/Sync hex terminal port card (six ports per card)
Qty. 1 **\$1,250**
- #60154** SDLC hex terminal port card (six ports per card)
Qty. 1 **\$1,750**
- #60156** Automatic Line Switch card (ALS)
Qty. 1 **\$750**
- #60157** Multiprotocol Software option. One per unit for sync support
Qty. 1 **\$1,000**
- #26230** 9600 bps V.29 integral modem
Qty. 1 **\$1,450**
- #26348** 14.4 kbps integral modem
Qty. 1 **\$2,420**
- #60168** 1.5 ft. straight through cable (one per modem card)
Qty. 1 **\$25**
- #88860** 6015 Device License Fee for 9800 NMS **\$150**

Note: Volume discounts are available. Call for information. Codex 6015 replaces Codex 6002 and 6005 muxes.



TYPICAL CONFIGURATION PRICES

- 4-channel async mux with 9.6 kbps integral modem and cable. . . **\$2,975**
- 10-channel async mux with 9.6 kbps integral modem and cable. . . **\$4,225**
- 16-channel async mux with 9.6 kbps integral modem and cable. . . **\$5,475**

USER DESTINATION ROUTING (UDR) MODE

UDR Mode adds asynchronous port switching with contention and queuing to the 6015's fixed-mode capabilities. UDR terminal ports may be classified as either leased-line or dial-up.

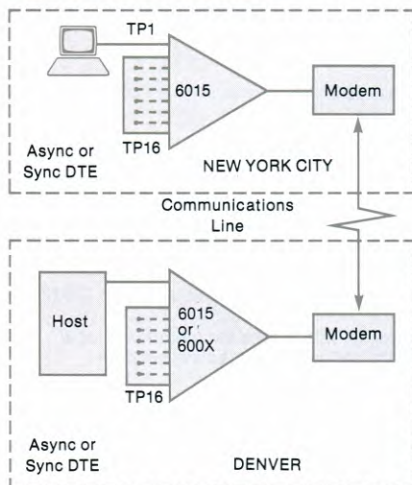

Figure 1. Permanent virtual connections can be made between leased-line terminal ports.

Figure 2. Dial-up virtual connections can be made between any dial-up user port (e.g., USER 1) and any other dial-up terminal port. (Dial-up terminal ports support only asynchronous protocols, including the autospeed type.)

TYPICAL APPLICATIONS

Point-to-Point/Fixed Mode



User Destination Routing

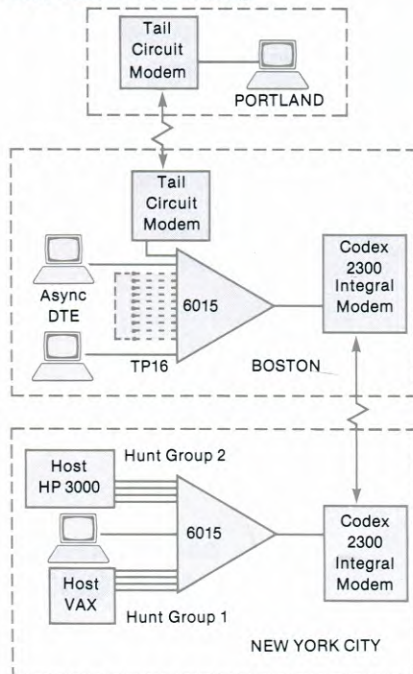

Point-to-Point/Fixed Mode

Codex 6015 terminal users in NYC are connected to a host computer located in Denver on a dedicated, fixed path basis (i.e., Port 1 in NYC only communicates with Port 1 in Denver, Port 2 in NYC only communicates with Port 2 in Denver, etc.).

Here, the Codex 6015 is equipped with Multiprotocol Software and SDLC Hex card options, permitting a mix of asynchronous, bisynchronous and SDLC terminal users to communicate with their respective hosts via a *single* high-speed line.

User Destination Routing

With User Destination Routing, any of sixteen asynchronous terminal users located in Boston and Portland can access two different applications residing on two different NYC hosts (HP 3000 and DEC VAX)*. (While there may be up to 16 users, only eight host computer ports are available at any time in this application).

The four HP 3000 ports are configured to belong to Hunt Group 1 and the four VAX ports to Hunt Group 2.

Any of the 16 users wishing to connect to the HP 3000 or DEC VAX can do so by selecting the appropriate Hunt Group numbers assigned to each application from the 6015 Hunt Group menu (e.g., Hunt Group 1 for HP 3000 and Hunt Group 2 for DEC VAX).

If all computer ports are "busy" when the user selects a particular Hunt Group, the local Codex 6015 displays a "busy destination" message at the user terminal and offers the user the option to disconnect, make another selection, or be placed in a queue and be connected as soon as a Hunt Group port becomes available.

The benefits? Codex's UDR has reduced the number of computer ports required to serve the user population by 50%—eliminating the need to dedicate a specific computer port to each individual user.

* HP 3000 is a trademark of the Hewlett Packard Corporation. VAX is a trademark of the Digital Equipment Corporation.



MULTIPLEXERS



**CODEX
6003**

SPECIFICATIONS

Power Requirements: 115 Vac, 30W max.

Leased Line Interface: The integral modem models require AT&T Type 3002 unconditioned leased lines.

TO ORDER

#60334	6003, 4-channel multiplexer	
	Qty. 1-3	\$1,250
	4-8	\$1,190
	9+	GC
#60364	6003, 4-channel with integral 9600 bps V.29 modem	
	Qty. 1-3	\$2,700
	4+	GC
#60335	6003, 8-channel multiplexer	
	Qty. 1-3	\$1,900
	4-5	\$1,805
	6+	GC
#60365	6003, 8-channel with integral 9600 bps V.29 modem	
	Qty. 1-2	\$3,350
	3+	GC
#24060	Rack-mount kit for 19-inch equipment rack	
	Qty. 1-9	\$125
	10+	\$105

Cables included: a network port to modem cable (15-foot in basic models, 6-inch in integral modem models) and product manual are included.

A variety of EIA cables are available to connect terminals and modems to the Codex 6003. See "Cables", page 47.

Note: Not field upgradeable from 4 to 8 channels.

Advanced performance in a low-cost, easy-to-use async statistical multiplexer.

- Supports up to 8 asynchronous devices; point-to-point operation
- High throughput efficiency using statistical multiplexing techniques
- Fully menu-driven operation, with front panel LCD for ease-of-use and special network access
- Data rates from 75 to 9600 bps, with autospeed to 9600 bps
- Network port support with synchronous trunk rate to 19.2 kbps and CCITT X.25 Level 2 compatible link protocol
- Downline loading of configuration information
- Special support for Hewlett-Packard systems
- Optional 9600 bps (CCITT V.29) integral modem, and optional rack-mount kit
- Ask about our extended warranty or see page 57

TYPICAL APPLICATION

Remote dial-in devices are easily handled by our multiplexers, which also accommodate local terminals operating at diverse speeds. The integral modem option eliminates the need for separate hardware.

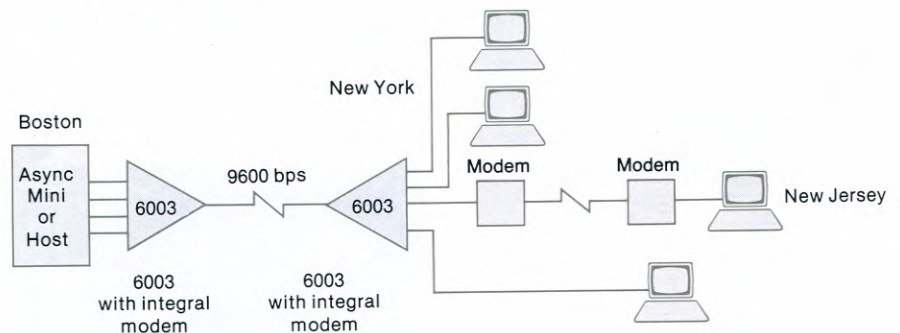

**CALL CODEX EXPRESS
800-446-6336**



**CODEX
6216**

**TO ORDER
(CONFIGURED UNITS)**

#38171	6216, 4-channel (Non-redundant)	Qty. 1\$4,575 3+GC
#38176	6216, 4-channel (redundant)	Qty. 1\$6,215 2+GC
#38177	6216, 8-channel (redundant)	Qty. 1\$7,210 2+GC
#38179	6216, 16-channel (redundant)	Qty. 1\$9,200 2+GC
#38181	Enhanced 6216, 4 channel (non-redundant)	Qty. 1\$5,250 2+GC
#38182	Enhanced 6216, 4-channel (redundant)	Qty. 1\$6,890 2+GC
#38183	Enhanced 6216, 8-channel (redundant)	Qty. 1\$7,885 2+GC
#38184	Enhanced 6216, 16-channel (redundant)	Qty. 1\$9,875 2+GC
#88876	6216 Device License Fee for 9300 NMS\$220 (There is no fee for the first six devices; license fee applies only to seventh and subsequent devices.)	
#88864	6216 Device License Fee for 9800 NMS\$295	

High performance mux combines up to 16 channels in a single high-speed link.

- TDM with aggregate digital transmission rates of 48 to 256 kbps (typical applications)
- Supports a mix of synchronous data rates from 1200 bps to 64 kbps; asynchronous data rates from 1200 bps to 24 kbps
- Single site control of Codex 6216 network
- Transparent reconfiguration without service interruption to unchanged channels
- Automatic downline loading of multiplexer link parameters
- Channel routing
- Up to four programmable configurations
- Automatically-switched redundant common logic cards and interface drivers (optional)
- Independent transmit and receive channel data rates
- Accommodates digital and analog tail circuits
- May be used with Codex 2172 LDM for local network
- Aggregate digital rates of 96-256 kbps selectable for larger applications
- Enhanced Codex 6216 also offers: alarm reporting, two additional loopback testing modes accessed from any CRT, and Codex network management support.

SPECIFICATIONS

Operation: Point-to-point.
Data Rates: Aggregate digital: 48, 56, 64, 72 or 80 kbps or selectable 96-256 kbps.
Terminal port:
 (Synchronous): 1200 bps to 64 kbps.
 (Asynchronous): 1200 bps to 19.2 kbps.
Power Requirements: 115 Vac, 95W typical.
Overhead Requirements: Overhead is dependent upon the channel configuration of a network and the multiplexer frame length. In most applications, the minimum overhead required is 2000 bps. However, if the rate of any one channel is greater or equal to one-half the aggregate rate, then the minimum overhead required is 1600 bps.
Size: 17 in. (W) × 7 in. (H) × 16 in. (D); Wt. 41 lbs.

TYPICAL APPLICATION

Digital Network with Modem Tail Circuit.

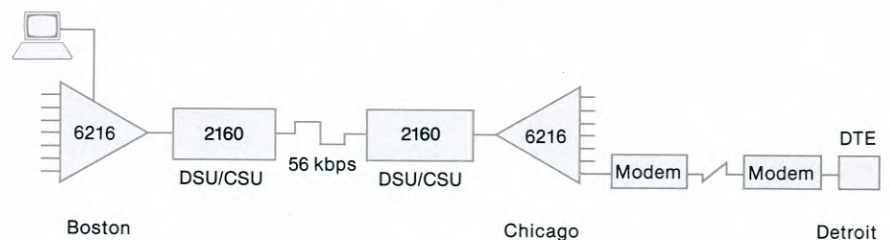

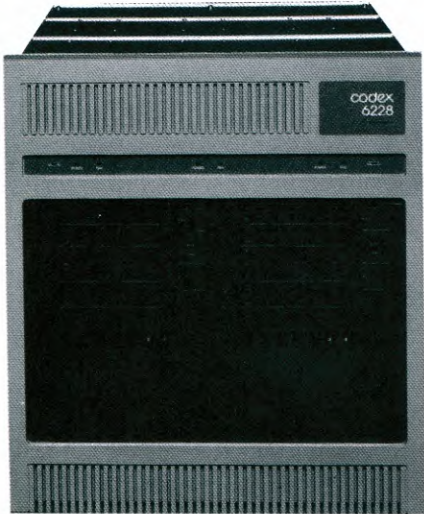

**CODEX
ENHANCED
6228**

TO ORDER

- #38191 Enhanced 6228, 4-channel (1 mux), non-redundant
Qty. 1\$6,605
2+ GC
 - #38192 Enhanced 6228, 28-channel (1 mux), redundant
Qty. 1 GC
 - #38193 Enhanced 6228, 40-channel (2 muxes, one with V.35 channel port)
Qty. 1+ GC
 - #38194 Enhanced 6228, 56-channel (2 muxes, one with V.35 channel port)
Qty. 1+ GC
 - #88865 Enhanced 6228, Device License Fee for 9800NMS \$500
 - #88877 Enhanced 6228 Device License Fee for 9300 NMS.....\$350
- (there is no fee for the first six devices; license fee applies only to seventh and subsequent devices.)*

Streamline your digital communications with two 28-channel muxes in a single enclosure

- Aggregate digital transmission rates from 48 kbps to 256 kbps
- Supports up to two TDM multiplexers, each concentrating up to 28 channels
- Network management provides time-of-day reconfiguration and diagnostic testing
- Complete, automatically switched redundancy common logic, interface driver and power supply
- Transparent reconfiguration without service interruption to unchanged channels
- Channel routing
- Accommodates digital and analog tail circuits, satellite networks
- V.35 and X.21 channel port interfaces for high speed port transmission
- Fully compatible with standard and enhanced versions of Codex 6216

SPECIFICATIONS

Power Requirements: 110 or 240 Vac, + or - 10%, 47 to 63 Hz; normal power consumption: 234W

Size: Height: 21 in. (W) x 19 in. (D) x 21.25 in. (H); Wt.: 120 lbs. fully configured.

Aggregate Data Rates: 4.8, 56, 64, 72, 80, 96, 112, 128, 144, 160, 192, 224, 256 kbps.

Port Data Rates: Synchronous: 1200 bps to 64 kbps; Asynchronous: 1200 bps to 24 kbps

Overhead Requirements: Application speeds up to 80 kbps, minimum overhead 2000 bps; aggregate speeds from 96 kbps to 160 kbps, 3200 bps overhead; speeds from 192 kbps to 256 kbps, 4800 bps overhead.

TYPICAL APPLICATION

Digital Network with Modem Tail Circuit

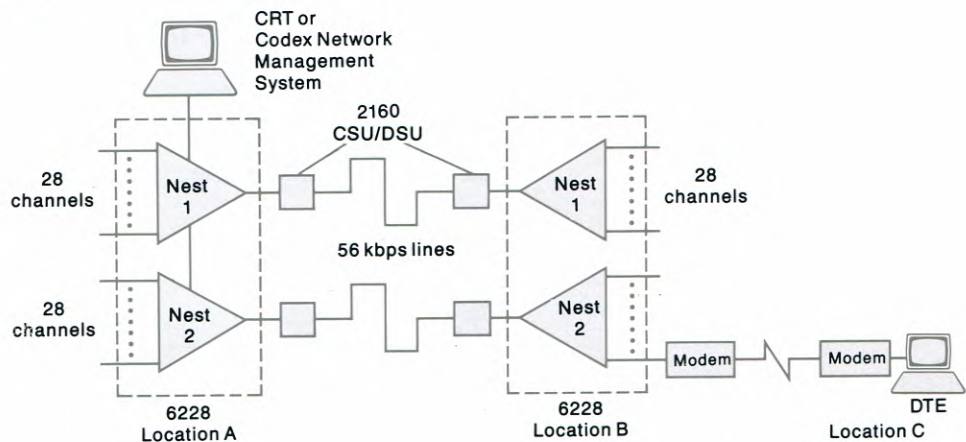

**CALL CODEX EXPRESS
800-446-6336**

Options and Accessories

Help boost productivity and cut transmission costs with Codex options and accessories

Our advanced data communications accessories are engineered to help you get the most from your Codex products in the widest range of applications.

Some of the most popular items offered in this section include: the Codex 2185 Digital Bridge. It helps you save money in hardware costs by letting several users share a single Codex modem

or computer port—*eliminating* the need to purchase additional modems or ports.

For maximum uptime and throughput in your critical leased line applications, take a look at the Codex 2025 A/B switch, which allows automatic switching of data terminal equipment from one circuit to another. Or the Codex 2010 Dial Backup Unit, which lets you “protect” your vital data channels with *automatic dial line backup* that keeps your data moving smoothly and reliably in the event of leased line failures.

And for streamlining operations in your high density sites, the Codex 2000 Series nest is an ideal solution. You’ll save valuable space in your high density facilities—*plus* our lower-cost cards will save you money!

You’ll also find tech control products, cables, racks, and hardware and software options for the Codex 6740, 6742/45 FNX and 9300 network management system. Plus a lot more to help make your job easier.



OPTIONS and ACCESSORIES



Leased line backup and equipment sharing with this flexible automatic A/B switch.

TO ORDER

#77997	2025 automatic A/B switch with power supply	
	Qty. 1-3\$375
	4-9\$350
	10+\$325

RS-232 applications(15-ft. cables)

#66186	RS-232M/RS-232M\$60
#22345	RS-232F/RS-232M\$60

V.35 applications (6-ft. cables)

#48523	RS-232M/V.35F (V.35 adaptor cable)\$100
#77998	RS-232F/V.35F\$100
#77999	RS-232M/V.35M\$100
#78000	RS-232F/V.35M\$100

See page 15 for typical Codex 2025 applications

- Automatic or manual switching between two circuits
- RS-232 interface
- V.35 interface via converter cable
- Possible control signals for automatic mode: RTS, CTS, DSR, DCD, DTR
- Front panel LEDs indicate switch status

SPECIFICATIONS

Interfaces: Three 25 pin D Subminiature Connectors (Female); COMMON, Port A, Port B.

Pins Implemented: 23 leads of the RS232 interface are switched. Pin 1, Frame Ground is Common and Pin 7 signal ground is common.

Indicators: Two red LED's indicate switch status A or B. LED's are driven by relay logic.

Size: 8 in.(W) x 2.75 in.(H) x 6.25 in. (D); Wt. 1.2 lbs.

External control and status interface: 9 pin D subminiature, Female.

Power Requirements: UL approved wall mounted power supply. 115 Vac 60Hz

Added flexibility with fast, easy switching from one analog path to another.



CODEX Analog Patch

- Two-wire or four-wire analog patching
- Miniature (Bantam) configurations
- Standard 50-pin telephone connectors on rear
- FCC Part 68 approved

Operation: Analog Jackfields perform patching on up to 24 four-wire or 48 two-wire lines. By using a standard single or dual patch cord, reconfigurations of a circuit can be performed easily.

Dual patch cords are used for four-wire circuits, while single patch cords are used for two-wire circuits.

SPECIFICATIONS

Connections: Analog Bantam: 2 female 50-pin line. 2 male 50-pin equipment.

Interface: Analog: 50-pin amphenol.

Size: Analog Bantam: 19.0 in. (W) x 1.75 in. (H) x 9.0 in. (D); Wt. 6.75 lbs.

TO ORDER

#47657	48-position Bantam analog patch (JC2/48M)	
	Qty. 1\$685
#47659	Analog patch cord, 3-foot Bantam single (PJ716)	
	Qty. 1\$20
#47700	Looping plug (PJ746)	
	Qty. 1\$8
#47701	Patch cord, 3-foot Bantam dual (PJ766)	
	Qty. 1\$16
#47702	Patch cord conversion, Bantam to long frame (PJ946)	
	Qty. 1\$22
#47703	Cable kit (one per Bantam Jackfield) (CBL5). Included are two 5-foot cables for the line side and two 25-foot cables for the equipment side. Four punch-down blocks are also included	
	Qty. 1\$275

**CALL CODEX EXPRESS
800-446-6336**

Provides flexibility and cost-effective solutions to modem and port sharing.

- Functions as a modem or port sharing unit
- Supports up to 5 terminals or modems in any combination; channels can be configured as terminal or modem interfaces by using switches accessible behind swing-down front panel
- Handles synchronous or asynchronous data
- Accommodates internal or external timing with fallback to internal should external timing be removed



**CODEX
Line
Sharing
Unit**

- The Codex Line Sharing Unit (LSU) provides conventional audio bridging in a polled network. The audio signal is received concurrently at all remote polled terminals.
- Extends distance capabilities of limited distance modems in multipoint applications, to that specified in the point-to-point performance specifications
- Enables user to bridge up to eight separate multipoint lines into one "master" limited distance modem (LDM)
- Tandem operation permits expansion beyond eight lines

- Cross-Over cables are never required
- Enhanced features include anti-streaming, dial modem and split speed support

SPECIFICATIONS

Data Rates: Sync/Async—19,200/9600/7200/4800/2400/1200/75 bps (internally strap-selectable); externally clocked: 0-19.2 kbps.

Data Buffer: Elastic storage buffer with capability of ± 4 bits.

Power Requirements: 90-132 VAC, 180-264 VAC, 47 to 63 Hz, 10W max.

Size: 8.5 in. (W) \times 3.0 in. (H) \times 16.0 in. (D); Wt. 4.5 lbs.

Provides for contention, reception, and broadcast transmission in a polled network.

- Allows for unattended remote loopback testing in multipoint applications when limited distance modems are installed

TO ORDER

- #47057 Line sharing unit mainframe (does not include common logic card or cable).
Qty. 1 \$720
- #47038 Common logic mainframe card. For use with Codex 8250, 212X, 217X, LDMs
Qty. 1 \$225

LSU Line Cards

- #47034 Line interface card. Supports Codex 2172 LDM
Qty. 1 \$180
- #47036 Line interface card. Supports Codex 2171 LDM
Qty. 1 \$165
- #47039 Line interface card. Supports Codex 2123 LDSU
Qty. 1 \$195



**CODEX
2185** **NEW!**

TO ORDER

- #28500 2185, 5-channel digital bridge
Qty. 1-3 \$795
4-9 \$771
10-12 \$747
13+ GC

Cables included: one 15-foot, male-to-male cable is provided with the 2185. Additional EIA cables for modem and port sub-channels may be ordered. See cable listing on page 47.

LSU Cables

- #47026 15' Audio cable to connect LSU mainframe to its associated modem
Qty. 1 \$20
- #47027 30' Audio cable to connect LSU mainframe to its associated modem
Qty. 1 \$30
- #47028 45' Audio cable to connect LSU mainframe to its associated modem
Qty. 1 \$40

SPECIFICATIONS

Interface: LSU 47057 provides for interconnection to four-wire full-duplex unloaded metallic baseband lines and is balanced at 150 ohms for transmit and receive circuitry.

Physical: 5.25 in. (H) \times 19 in. (W) \times 10 in. (D); Wt. 15 lbs.

Protects your critical leased line data paths via public dial network.

- Choice of three operating modes: leased line, backup or test/status configurations
- Fully automatic operation with manual override
- Automatic dialing of two stored numbers, up to 30 digits each
- Automatic answer allows unattended remote sites to be placed into dial backup under the central site operator's control
- FCC registered for direct connection to the Public Switched Telephone Network (PSTN)
- Front panel controls and status indicators; optional front panel lockout switch
- Terminal port for external DCE access
- Non-volatile telephone number storage

TYPICAL APPLICATION

The Codex 2010 reroutes your data via dial lines, in the event of a leased line failure.

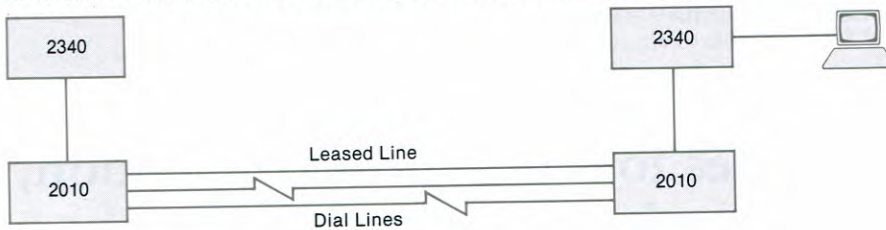

CODEX 2010

SPECIFICATIONS

Control Port Data Rates: 75, 150, 300, 1200, 2400, 4800, 9600 bps asynchronous.

Operating Mode: Originate, Answer, Auto-Answer, Auto-Dial.

Digital Interface: EIA 232-C.

Tone Generation: Standard touchtone, echo, abort, answer.

Telephone Line Interface: Programmable data jacks (RJ45S) or permissive "voice" jacks (RJ11C).

Size: 9.76 in. (W) x 2.42 in. (H) x 10.81 in. (D); Wt. 4.1 lbs.

TO ORDER

#22326	2010 dial backup unit	
	Qty. 1-3\$850
	4-9\$810
	10-12\$785
	13+GC



CODEX 2207

SPECIFICATIONS

Data Rate: 75 to 9600 bps.

Power Requirements: 115 Vac, 10W nominal.

Dialing Outputs: Pulse (801A), Tone (801C).

Call Termination: DTE turns off CRQ prior to call completion.

Abort Timer: Strap-selectable 32, 48 or 96 sec. or disabled.

Certification: FCC Reg. No. AK396F-13219-DI-E.

Telephone Interface: RJ45S, RJ11C.

Size: 9.3 in. (W) x 2.25 in. (H) x 10.32 in. (D); Wt. 3.4 lbs.

Microprocessor-based unit lets you upgrade your dial modem for automatic calling.

- Accepts digital dialing inputs at rates from 75 to 9600 bps
- Offers serial (EIA 232-C) or parallel (RS-366-A) digital interfaces
- Speaker options which, when enabled, allow call progress monitoring
- UL and CSA approved; FCC registered for direct connection to dial lines
- Functions through any FCC registered modem
- For use with most Codex dial modems
- LED indicators to monitor operation

TO ORDER

#25806	801 ACU standalone, serial or parallel, pulse or tone	
	Qty. 1-9\$670
	10-15\$640
	16+GC
#25953	801 ACU nest card	
	Qty. 1-9\$560
	10-18\$530
	19+GC



An async Packet Assembler/Disassembler—supports link and port speeds to 9600 bps.

- Compatible with 1980 recommendation for X.25, X.3, X.28, X.29 and X.121
- Certified on Telenet, Tymnet, Uninet, KDD Network support, and over 20 international networks
- Supports the following X.25 facilities: Fast Select, Closed User Groups, Reverse Charging, Throughput Class Negotiation, Window and Packet Size Negotiations, and Priority (DATAPAC)
- Supports Switched Virtual Circuits and Permanent Virtual Circuits

SPECIFICATIONS

Asynchronous Data Rates: 50, 75, 110, 134.5, 150, 200, 300, 600, 1200, 1800, 2400, 4800 and 9600 bps

Autobaud: 50 to 9600 bps

Data Codes: 5, 6, 7 or 8 bits per character

Stop Bits: 1, 1.5 or 2 stop bits per character

EIA Controls: four signals—function configurable

Flow Control: EIA (CTS/DTR) or XON/XOFF

Compatibility: CCITT (1980) Recommendation X.25, LAPB/HDLC Operation

Trunk Rates: 2400, 4800, 9600 bps synchronous

Size: 4.5 in. (H) × 15.5 in. (W) × 11.75 in. (D); Wt. 8 lb.

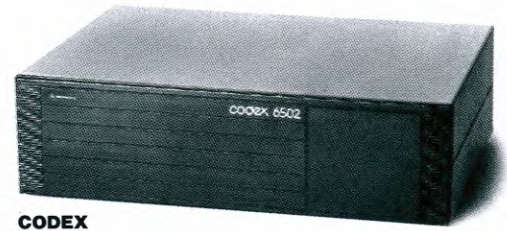

**CODEX
6502**

TO ORDER

#65540	6502 4-channel unit	
	Qty. 1-5	\$1,800
	6+	GC
#65544	6502 10-channel unit	
	Qty. 1-3	\$3,100
	4+	GC
#65548	6502 16-channel unit	
	Qty. 1-2	\$4,400
	3+	GC
#65552	6502 Hex expander card	
	Qty. 1-7	\$1,300
	8+	GC
#65553	Standard 19" rack mount kit	
	Qty. 1	\$75



Use your async equipment with your synchronous modem—at speeds up to 19.2 kbps.

- Supports speeds up to 19.2 kbps, half-duplex, or full-duplex
- Allows asynchronous data terminals to be used with synchronous data communications equipment
- EIA 232-C and CCITT V.24 compatible
- ASCII or BCD Code Compatible
- Point-to-point or multipoint operation
- Power derived from the data communications equipment

SPECIFICATIONS

Operating Speeds: Strap-selectable from 150 bps to 19.2 kbps. The speed of the modem should be equal to or higher than the selected terminal speed.

Memory: 40-bit buffer.

Power Requirements: Derives power from Codex modem via pins 9 and 10 or from the following EIA/V.24 signals:

- Pin 2—Transmit Data
- Pin 15—Transmit Clock
- Pin 3—Receive Data
- Pin 17—Receiving Clock
- Pin 6—Data Set Ready
- Pin 8—Data Carrier Detect

Size: 5.375 in. (W) × 1.875 in. (H) × 11.125 in. (D); Wt. 8.125 lbs.

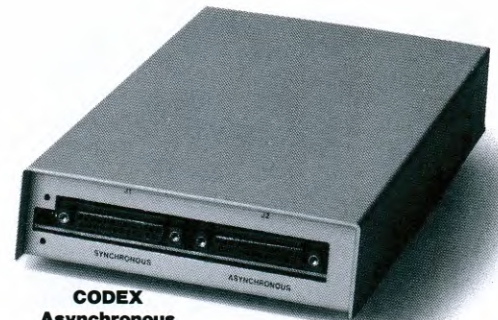

**CODEX
Asynchronous
to Synchronous
Converter**

TO ORDER

#47030	Async to sync converter	
	Qty. 1-3	\$395
	4-9	\$375
	10-19	\$365
	20-34	\$355
	35+	\$350

Note: Includes one 15-foot, 24-pin male-to-male connector.

OPTIONS and ACCESSORIES

Easily monitor and maintain your communications systems in standard EIA equipment racks.

- Conveniently store all your Codex catalog products in standalone racks
- Provides an attractive, organized method of monitoring and maintaining your communications equipment
- Store operating and standby modems, patch panels and test equipment in any size rack
- Mount your patch and test equipment separately or along with operating equipment
- Available in three sizes: 28-, 42- and 70-inches high

TO ORDER

Equipment racks

- #66190 28-inch equipment rack.
Qty. 1\$575
- #66191 42-inch equipment rack.
Qty. 1\$1,050
- #66192 70-inch equipment rack.
Qty. 1\$1,150

Options

- #47514 Blower assembly.
Qty. 1\$450
- #47515 Plexiglass door (for 70-inch rack)
Qty. 1\$785
- #47516 Equipment shelf.
Qty. 1\$60
- #47519 9-position power strip.
Qty. 1\$65

**CODEX
Equipment
Rack**

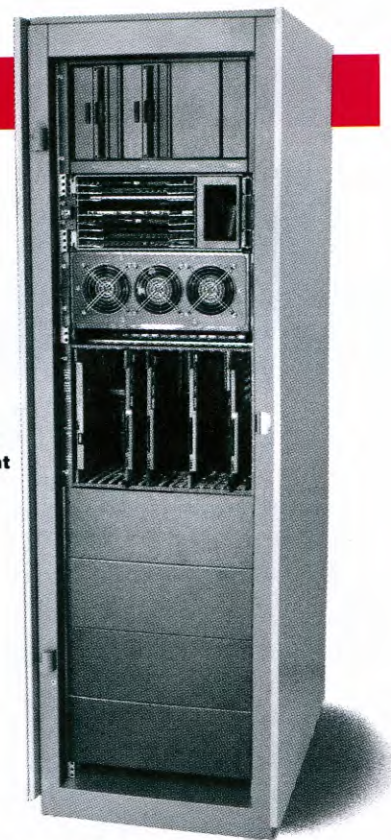

SPECIFICATIONS

Requires floor space approx. 2 ft. wide by 2 ft. deep. In addition, the rack should allow at least 3 ft. behind it for easy access for maintenance. Standard racks contain secondary rails and an AC power strip. Note: Equipment installed for demonstration only.



**CODEX
2000
Series Nest**

TO ORDER

- #26750 Codex 2000 Series nest (115V power supply)
Qty. 1-6\$1,500
7+GC
- #26754 Redundant power supply (115V)
Qty. 1\$750
- #26301 Fan assembly (115V)
Qty. 1\$200

Single space-saving unit supports up to 16 card modems—ideal for high-density sites.

- Accommodates leased line point-to-point or multipoint and mux option cards
- Compatible with Codex 2300 Series leased line modems; Codex 2230 Series dial line modems; Codex 2150/60 DSU/CSU; and Codex 2260 Series dial line modems
- See-through, drop-down front panel allows quick monitoring of status indicators
- Optional redundant power supply, with "hot" automatic switch-over to spare supply
- Optional fan assembly

SPECIFICATIONS

Enclosure Capacity: Up to 16 nest cards.

Enclosure Power Requirements: 115 Vac. Maximum power: 300W (loaded nest).

Fan Assembly Power Requirements: 70W maximum.

Air Flow: Free air delivery of 300 CPM.
Card size: 75 in. (W) × 8.0 in. (H) × 15.50 in. (D).

Enclosure Size: 19.0 in. (W) × 10.50 (H) × 21.50 in. (D); Wt. 38 lbs. Includes one power supply, nest chassis, bezel and no cards. Wt. 66 lbs. for two power supplies, nest chassis, bezel and 16 modem cards.

Fan Assembly Size: 19.00 in. (W) × 5.25 in. (H) × 14.20 in. (D); Wt. 15 lbs. (Fan assembly and fan bezel).

Nest height with fan: 14 in.

Choose from a variety of Codex cables to meet all your network requirements.

Audio Cables

- **Modular Jack Cables** connect modems or telephones to modular telephone jacks; or connect telephones to modems.
- **Half-Modular Cables** have a modular plug on one end and spade lugs on the other end.

Digital Cables

- **Male-to-Male Connectors** can be used as follows: to connect a modem or multiplexer to a digital patch panel or a digital sharing device.
- **Male-to-Female Connectors** connect a DTE interface to a modem, multiplexer or Digital Sharing Device; or connect a multiplexer's network port to its trunk modem.
- **Cross-Over Cables** connect tail-circuit modems to other modems or to a multiplexer's terminal port.

TYPICAL APPLICATIONS

Male-to-Male connectors

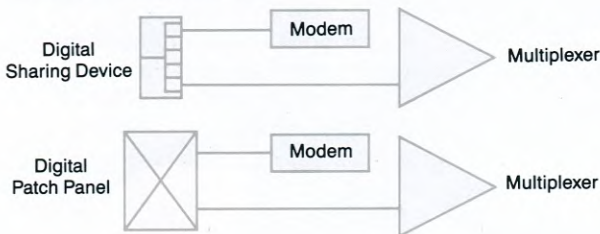

Male-to-Female connectors

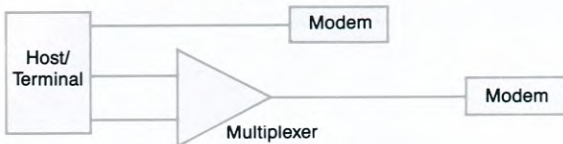

Cross-Over cables

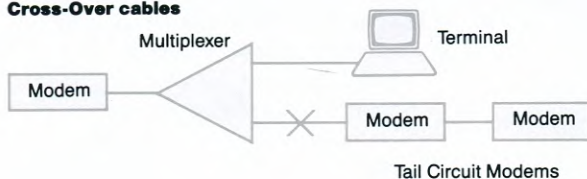

TO ORDER

Straight-Through, EIA 232-C

- #22345 Male-to-Female, 15-ft. \$60
- #22346 Male-to-Female, 30-ft. \$70
- #22347 Male-to-Female, 45-ft. \$90
- #66186 Male-to-Male, 15-ft. \$60
- #66187 Male-to-Male, 30-ft. \$70
- #66188 Male-to-Male, 50-ft. \$90

Cross-Over, EIA 232-C

- #66180 Male-to-Male, 15-ft. (17 conductor) \$60
- #66181 Male-to-Male, 30-ft. \$70
- #66182 Male-to-Male, 50-ft. \$90
- #99510 Male-to-Male, 15-ft. (8 conductor, shielded) \$60

Modular Jack, Audio

- #99050 RJ-11 plugs on both ends, 7-ft. (4 wires) \$10
- #99060 8-pin FCC dial cable, RJ-45 plugs on both ends, 7-ft. (8 wires) \$10
- #99068 6- to 8-pin FCC dial cable, RJ-11 plug on one end, RJ-45 plug on the other end, 7-ft. (2 wires) \$10

Half-Modular, Audio

- #99055 6-pin half-modular, RJ-11 plug on one end, spade lugs on the other end, 7-ft. (4 wires) . . . \$10
- #99065 8-pin half-modular, RJ-45 plug on one end, spade lugs on the other end, 7-ft. (8 wires) . . . \$10

Y-Cable

- #99576 Y-Cable for CS & Codex 2600 series \$90

Power Cord

- #02323 Additional power cord for LSI, CS, 6000 series. \$25

Straight-Through V.35

- #47959 Male-to-Male, 15-ft. \$110
- #47960 Male-to-Male, 30-ft. \$130

Cross-Over V.35

- #47956 Male-to-Male, 15-ft. \$110
- #47957 Male-to-Male, 30-ft. \$130

EIA 232-C to V.35 Adapter Cables

- #48523 EIA 232-C Male to V.35 Female, 6-ft. \$100
- #77998 EIA 232-C Female to V.35 Female, 6-ft. \$100
- #77999 EIA 232-C Male to V.35 Male, 6-ft. \$100
- #78000 EIA 232-C Female to V.35 Male, 6-ft. \$100

OPTIONS AND ACCESSORIES

Enhance your network with Codex 6740, 6742/6745 and 9300 Options—a selection of networking products now available through our “Quick-Ship” Program.

6740 Network Port Options Network Port Card. Provides connections to network of muxport links.

#67460\$1,200

Dual EIA Interface Card. Supports two RS-232-C/V.24 interfaces for the Network Port card.

#67462No charge with #67460

Quad EIA Interface Card. Added to the base Network Port card making four RS-232-C/V.24 interfaces available without taking up additional slots in the nest.

#67461\$700

Wideband Interface Card. This interface card is added to the base Network Port card to support one fully loaded V.35 connection at speeds up to 64 kbps. Two V.35 connectors are provided.

#67465\$500

6740 Terminal Port Options

Terminal Port Processor. Supports four RS-232-C terminal connections directly. Depending on terminal speeds and utilization, up to two additional Terminal Hex Expansion cards may be added to each TPP.

#67450\$1,200

Terminal Hex Expansion Card. Works with a Terminal Port Processor. One TPP can drive up to two Terminal Hex Expansion cards.

#67455\$1,200

2-position Terminal Port Bus Card. Required when adding a Terminal Port Processor card and a Terminal Hex Expansion card.

#67456No charge with #67455

3-position Terminal Port Bus Card. Required when adding a Terminal Port Processor card and two Terminal Hex Expansion Cards.

#67457No charge with #67455

Add options to your Codex Flexible Networking Exchange products for increased I/O or additional functionality.

6742/45 Hardware Options Terminal Processor (TP). TP board supports eight EIA 232-C terminal/host DTE connections.

Depending on terminal speeds, utilization, an additional eight-port Terminal Processor Expansion (TPE) board may be added to each TP.

#67572\$2,300

Terminal Processor Expansion (TPE). Use with Terminal Processor board to provide lower-cost DTE port. Each TPE supports eight EIA 232-C terminal/host DTE connections.

#67574\$1,600

Network Processor (NP). Provides two EIA 232-C connections. Ports operate at clock rates up to 19.2 kbps each, support either networking links or muxport links.

#67576\$1,900

V.35 Network Processor. Provides two wideband CCITT V.35 connections, two ports operating at clock rates up to 64 kbps each. Supports either networking links or muxport links.

#67579\$1,900

Diagnostic Loop-Back Plug Set. Allows loadable TP/NP/XT diagnostic software to perform external loop-back diagnostics on port processor boards.

#67598\$150

6742/45 Software Options

6742/6745 Basic Systems Software. Enables node to perform data concentration and statistical multiplexing. Required for basic operation.

#67550\$1,000

Copies\$300

FNX Loadable TN/NP/XP Diagnostic Software. Allows operator to perform troubleshooting on FNX port processor hardware throughout network. Equal to factory-run diagnostics.

#67552\$1,000

Copies\$300

Adaptive Data Compression (ADC). Supports ADC on Terminal Processor ports 1-4 leaving ports 5-8 usable for non-ADC applications. Fully compatible across 6740 family.

#67562\$2,500

Copies\$300

User Destination Routing Support. Asynchronous terminal users select their destination within Codex family network, either terminal or hunt group. Contention, “camp-on” queuing are standard. Terminals using muxport-connected Codex 6000 Series INP or 6760 can also access UDR.

#67564\$2,500

Copies\$300

Synchronous Protocol Support. Supports over 26 byte-synchronous and bit-synchronous type protocols. Required if byte-synchronous or bit-synchronous threads are used in FNX network.

#67566\$2,500

Copies\$300

Maximize your Codex 9300 system with I/O Expansion Kit

Use I/O Expansion Kits with systems that have more than eight control channels. Each kit supports up to eight additional control channels. Up to three kits can be installed per 9300 for maximum of 32 device-control channels per system.

9300 INMS 8-Channel I/O Expansion Kit. Contains all hardware to support eight additional control channels. Includes one 8-channel I/O card, one junction box, 50 ft. group cable, eight 4 ft. device cables.

#24960\$2,000

25 ft. Device Cable. Use when longer device cable is required.

#24966\$90

For one-stop shopping convenience, Codex Express presents a selection of products chosen to meet our own high standards for performance, quality and value.

Codex Express is committed to providing you with the highest quality products, plus one-stop shopping convenience. On the following pages we present special selections from leading vendors.

Each product is designed to boost performance and

productivity and was chosen only after meeting our own exacting standards for performance, value and the quality of service provided by each vendor.

Discover the V.35 Converters which allow you to connect V.35 devices to RS-232 devices. The converters operate with both async and sync equipment while transparent to speed, protocol and application.

Or take a look at the IBM Internal Dial Modem Card for either your IBM PC or PS/2 system. It provides full-duplex operation at data speeds of 2400,

1200, 600 and 300 bps over regular telephone lines. For ease of use, you get auto-originate and auto-answer modes plus Hayes compatibility and more.

Communications software is also included.

These products will make your networking easier and often save you money: breakout boxes for testing and troubleshooting, surge suppressors with 5-nanosecond response time, indispensable reference books, and more. And everything is available just by calling Codex Express at 800-446-6336!



Connect V.35 and RS-232 devices with Dataprobe's Interface Converters.

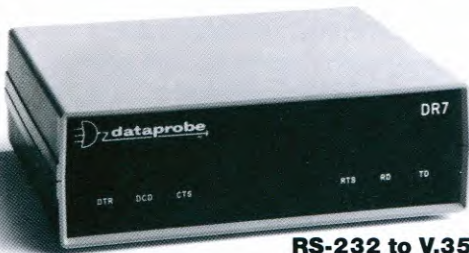

RS-232 to V.35 Interface Converter

NEW!

TO ORDER

- #48712 DR7 V.35 Converter
 - Qty. 1-8\$365
 - 9-24\$355
 - 25+GC
- #48711 K-DR7 V.35 Converter and Auto A/B Switch
 - Qty. 1-9\$565
 - 10-18\$548
 - 18+GC

- Interconnects V.35 and RS-232 devices
- Transparent to speed, protocol and application
- One-year warranty from Dataprobe

- Strap selectable for DTE or DCE operation
- Operates with asynchronous and synchronous equipment
- K-DR7: Automatic remote or manual switching of common V.35 data circuit between a V.35 device (port A) and an RS-232 device (port B)
- K-DR7: Possible control signals for automatic mode: RTS, CTS, DSR, DCD, DTR
- DR-7: Female 25-pin D Subminiature connector for RS-232 equipment and female 34-pin Winchester connector for the V.35 device are included

SPECIFICATIONS

Dataprobe DR-7 V.35 Converter

V.35 interface: 34-pin type "M" connector, female.

RS-232 interface: DB25 connector, female.

Indicators: DTR, DCD, CTS, RTS, RXD, TXD.

Size: 8" (W) × 2.75" (H) × 6.25" (D).

Dataprobe K-DR7 V.35 Converter and Auto A/B Switch

V.35 interface: Two 34" type female connectors. Common port and switched port A. **RS-232 interface:** 1 DB25 female connector, port B.

Leads switched: 17 leads switched, Pin A and Pin B common.

Size: 8" (W) × 2.75" (H) × 6.25" (D).



Surge Suppressor
NEW!

TO ORDER

- #48730 AC line surge protector
 - Qty. 1-9\$185
 - 10-24\$180
 - 25+\$170
- #48731 For RS-232 interfaces
 - Qty. 1-9\$99
 - 10-24\$95
 - 25+\$93
- #48732 Modem protector for leased lines
 - Qty. 1-9\$80
 - 10-24\$78
 - 25+\$75
- #48733 For RJ-11C jacks
 - Qty. 1-9\$67
 - 10-24\$65
 - 25+\$63
- #48734 RJ-45 jacks
 - Qty. 1-9\$124
 - 10-24\$120
 - 25+\$115

Transtector surge suppressors protect to the max with 5-nanosecond response time.

- Utilizes silicon avalanche diodes in a patented lattice matrix configuration providing a fast response time and low clamping point while dissipating the transient energy with no product degradation
- Product automatically re-sets to ready position with no loss of protective capability

- One-year warranty from Transtector

SPECIFICATIONS:

ACPI100BLN2 AC line surge protector (48730)

Voltage: 110/120 VAC

Current: 15 Amp. (Max)

DLP-3 for RS-232 interfaces (48731)

Pins Protected: 2,3,7

Model #	Voltage Clamping Point	Peak Power Dissipation	Response Time	Size	Signal Voltage	Leakage	Series Impedance
47830	300 volts peak	12,000 watts	5 nanoseconds	5"H×3"W×2"D	—	—	—
47831	16 volts peak	15,000 watts	5 nanoseconds	¾"H×2½"W×1½"D	15 volts peak	5u AMP	33 ohm
47832	6.6 volts peak	15,000 watts	5 nanoseconds	¾"H×2"W×2"D	4 volts peak	5u AMP	33 ohm
47833/4	200 volts peak	15,000 watts	5 nanoseconds	¾"H×2½"W×2½"D	160 volts peak	5u AMP	33 ohm

Diagnose cable, modem, DSU/CSU and printer interface problems with these handy breakout boxes.

The Model 1000 Breakout Box from Datacom Technologies is the comprehensive analysis tool—with three functions in one.



**Model
1000**

Features include:

- Three instruments in one: RS-232 interface tester, parallel interface tester, and a 25-conductor cable checker (with Model 25)
- Test probe provided allows connection to either test voltage as well as checking of every conductor for end-to-end continuity and pin interconnection
- Separate red and green LEDs on all 25 lines provide at-a-glance status of interface activity
- Loopback and null modem switches
- Dual gender connectors
- SoftPak case
- Lifetime warranty from Datacom Technologies
- Model 25 Remote Cable Monitor also available as accessory to simplify testing of cables within a wall or cable. Indicates connections on far end of cable resulting from power applied at breakout box.

Datacom Technologies Model 355M breakout box provides reliable testing for high-speed V.35 applications.

Features include:

- V.35 test capability to 1.544 Mbps
- RS-232 monitor to 64 kbps
- Plus-minus test voltages
- LED indicators monitor data lines, seven key control lines, and three clock signals (SCR, SCT, and SCTE)
- Two spare indicators for special line activity
- SoftPak case
- Lifetime warranty from Datacom Technologies

Datacom Technologies Model 55 is an economical breakout box for occasional troubleshooting.

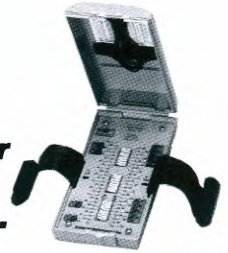

**Model
55**

Features include:

- Testing for RS-232 interface applications
- Ability to open and reconfigure all data and control lines
- Separate red and green indicators for each of the 12 most-used lines
- Convenient, compact size in tough molded plastic
- Lifetime warranty from Datacom Technologies

TO ORDER

#48704	Datacom Technologies Model 355M Breakout Box	Qty. 1-9\$669 10+\$649
#48706	Datacom Technologies Model 1000 Breakout Box	Qty. 1-9\$369 10+\$339
#48705	Datacom Technologies Model 55 Breakout Box	Qty. 1-9\$149 10+\$139
#48707	Datacom Technologies Model 25 Remote Cable Monitor (accessory for Model 1000)	Qty. 1-9\$59 10+\$49



**CALL CODEX EXPRESS
800-446-6336**

Simple, trouble-free, cost-effective—the 212A LP modem.

- Easy to install, plugs right into your computer and phone, no AC power needed because it draws its power from the phone line
- Compatible with both Bell 212 and Bell 103 at either 1200 or 300 bps
- Auto-answer/manual dial capability
- User can program 9, 10, or 11 bit word lengths, including start and stop bits
- Connections provided for normal voice use of telephone
- One-year warranty from Universal Data Systems

SPECIFICATIONS

Operation: Full duplex over dial lines.

Operation Modes: Manual originate/answer, autoanswer.

Transmitter Output Level: -9dBm permissive.

Telephone Line Interface: RJ11

Digital Interface: EIA 232-C

Data Rate: Synchronous, 1200 bps; asynchronous, 1200/300 bps.

Modulation Standards: Bell 212, Bell 103

Size: 6 1/8" (W) × 1 1/8" (H) × 9 1/2" (L).

TO ORDER

#48722	UDS 212A LP Modem	
	Qty. 1-9\$195
	10-24\$185
	25+\$175

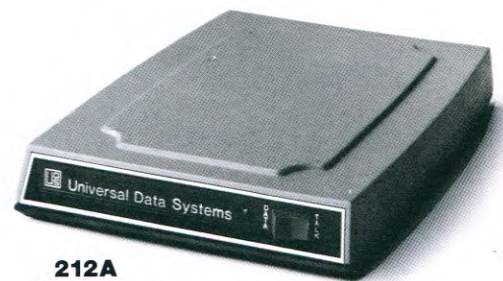

**212A
LP Modem**
NEW!



Codex Express product returns will be accepted within 30 days of shipment by calling 1-800-446-6336 for a Return Authorization Number (RMA). We will issue a full refund or credit promptly upon receipt of your return. No return will be accepted without an RMA number. We reserve the right to refuse returns after 30 days.



**LD A/19.2
Line Driver**
NEW!

TO ORDER

#48724	LD A/19.2 with female connector	
	Qty. 1-9\$95
	10-24\$90
	25+\$85
#48723	LD A/19.2 with male connector	
	Qty. 1-9\$95
	10-24\$90
	25+\$85

LD A/19.2 kbps—low-cost, reliable transmission of asynchronous data over short distances.

- Operates over range of 0.5 to 5 miles on EIA equipment
- Asynchronous data rates of up to 19.2 kbps
- Use over twisted pair lines (4 wires)
- One-year warranty from Universal Data Systems

SPECIFICATIONS:

Operation: Full-duplex, 4-wire.

Data Format: Asynchronous.

Range/Data Rates: 0.5 miles at 19.2k, 2 miles at 9.6k, 3 miles at 4.8k, 5 miles at 2.4k.

Line: Unloaded twisted pair with DC continuity 26 gauge or larger.

Digital Interface: EIA-232-C.

Power: Derived from EIA lines.

Size: 2.5" (W) × 2.1" (L) × 0.7" (H).

Enhance your IBM PC or PS/2 system with Internal Dial Modem Card.

- Data speeds of 2400, 1200, 600 and 300 bps
- Full-duplex operation on 2-wire public or private telephone lines
- Asynchronous operation
- Hayes compatible auto-dial, auto-answer allows 24-hour operation
- Nonvolatile memory for configuration and phone number storage
- Provides auto originate or auto-answer mode
- CCITT V.22/V.22 bis and Bell 103/21A compatible for communication with most U.S. and international modems
- Standard diagnostics for testing phone line quality and modems at each end are built in
- Automatic speed matching to originating modem
- Compatible with most communication software packages
- Includes Mirror II PC or PS/2 communications software
- Available as IBM half card (FasTalk 2400 PC) or IBM micro-channel BUS compatible (FasTalk 2/2400)
- Easy set-up, modem is factory-configured to plug in
- One-year warranty from Universal Data Systems

SPECIFICATIONS

Operation: Full duplex 2-wire, dial-up or private line, asynchronous auto-dial, auto-answer.

Data Rate: 2400, 1200, 600 and 300 bps.

Transmitter Output Level: Permissive, 9 dBm at modem (RJ11 jack).

Data Interface: PS/2 Micro Channel BUS compatible (FasTalk 2/2400), IBM ½ card (FasTalk 2400 PC).

Protocols: 2400bps: CCITT V.22/V.22 bis
1200bps: CCITT V.22 or Bell 212A
600bps: CCITT V.22
0-300bps: Bell 103

Test Modes: V.54 compatible loop tests.

TO ORDER

#48720	FasTalk 2400 PC internal modem (for IBM PC)	
	Qty. 1-9	\$495
	10-20	\$470
	20+	GC
#48721	FasTalk 2/2400 internal modem (for IBM PS/2)	
	Qty. 1-9	\$495
	10-20	\$470
	20+	GC

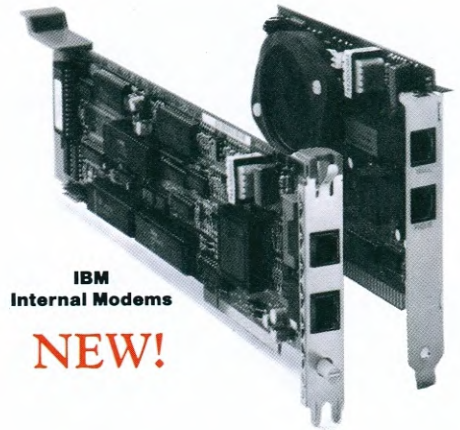

IBM
Internal Modems

NEW!





Reduce cabling and share equipment with these manual data switches from Hadax.

Two-way (AB) RJ11 and four-way (ABCD) RS-232 switches feature:

- Two-way RJ switch can provide dial or leased line backup
- Four-way RS-232 switch ideal for printer sharing or for multiple devices backing up a single circuit
- Highest quality components: PC board construction
- No power required
- All interface leads switched
- Size: 2 in. (H) x 7¼ in. (W) x 6 7/8 in. (D)
- Lifetime warranty from Hadax

TO ORDER

- #48710 Hadax RS-232 ABCD switch
Qty. 1-9\$164
10+\$159
- #48709 Hadax RJ11 AB switch
Qty. 1-9\$79
10+\$69

Keep up with the latest developments in the industry with these handy reference books.

Data Communications Standards, Edition III

edited by Harold C. Folts

This is the classic reference for instant access to American and international standards. Includes new and revised standards since the previous sell-out edition.

Cross referenced, indexed, and illustrated for quick and easy use, worldwide standards represented in over three volumes include:

- International Telegraph and Telephone Consultative Committee (CCITT)
- Electronic Industries Association (EIA)
- Federal Telecommunications Standards (FTS)
- Federal Information Processing Standards (FIPS)
- International Organization for Standardization (ISO)
- European Computer Manufacturers Association (ECMA)
- American National Standards Institute (ANSI)
- Omnicom Index of Standards for Distributed Information and Telecommunications Systems:

reference of all standards related to Open Systems Interconnection, ISDN, distributed information and telecommunications systems.

TO ORDER

- #48701 Data Communications Standards, Edition III (Folts, ed.) 4600 pages, 3 volumes; hardcover; copyright 1986\$445

Data Communications: A Comprehensive Approach

by Gilbert Held and Ray Sarch

Stay up to date in the changing datacomm field with this excellent textbook. You'll develop an understanding of basic datacomm, along with a basic knowledge of public and private networking. A few of the topics covered: basic transmission devices; regulatory agencies and communications vendors; common carrier offerings; interfacing data transmission devices; network planning and design alternatives . . . and much more!

TO ORDER

- #48702 Data Communications: A Comprehensive Approach (Held/Sarch) 441 pages; hardcover; copyright 1983\$44.50

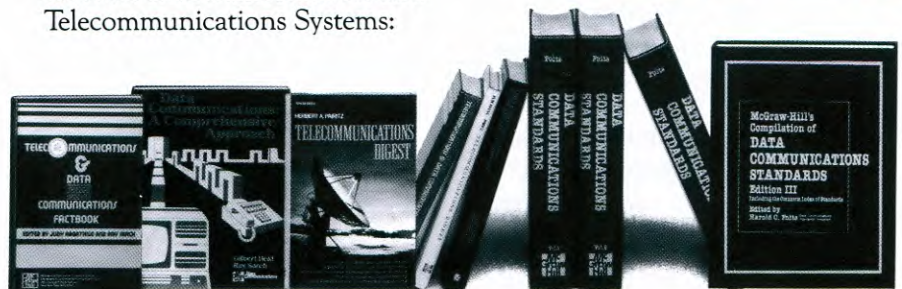

Telecommunications and Data Communications Factbook

edited by Ray Sarch and Judy Abbatiello

This handy reference contains the information you need to help you face the challenges of today's integrated communications networks. Contains terms and abbreviations . . . traffic formulas . . . dimension PBX features and definitions . . . regulatory and tariff directories . . . tutorials on OSI, traffic theory, local area networks, and much, much more!

TO ORDER

#48700 Telecommunications and Data Communications Factbook (Sarch/Abbatiello, eds.) 300 pages; hardcover; copyright 1987 \$41.95

Telecommunications Digest

by Herbert A. Pairitz

A quick course in telecommunications, this book includes all the information you need to help you understand and deal with practical, day-to-day telecommunications. It's the ideal primer for anyone interested in the most recent developments in data and voice communications. Packed with sound advice from a leading telecomm authority, this book features practical and theoretical information for managers, systems analysts and datacomm specialists.

TO ORDER

#48703 Telecommunications Digest (Pairitz) 288 pages; hardcover; copyright 1985 \$24.95

CALL CODEX EXPRESS
800-446-6336

Communications software and cabling bring the world to you at your PC. Now 25% off!

These communications software packages and cables work together with a PC modem (like the Codex FasTalks on page 9) to let you communicate with other PCs, access bulletin board services, perform file transfers, and connect to a host of other public networking services.

Mirror II (from SoftKlone Distributing Corp.) is an asynchronous datacomm package for IBM PCs and PS/2s (and compatibles) running IBM PC DOS or Microsoft MS-DOS operating systems;



MicroPhone 1.5 (from Software Ventures Corporation) is an asynchronous datacomm package for the Apple Macintosh. Both packages emulate most async terminals and provide simplified start-up for access to bulletin board and other network services.



Other **Mirror II** features include:

- Enhanced user interface supports same features as popular Crosstalk XVI software
- Integrated Wordstar text editor allows file editing from within Mirror II
- 60-day manufacturer's warranty

Other **MicroPhone 1.5** features include:

- Integrated text editor allows file editing from within MicroPhone
- Watch Me mode for simple script generation
- 30-day money-back guarantee from manufacturer

For a limited time only, take 25% off prices listed below when purchased with a FasTalk or dial modem!

TO ORDER

- #25992 Mirror II communications software (5 1/4" floppy disk) . . . \$70
- #25993 Mirror II communications software (3 1/2" diskette) . . . \$70 (Support provided by SoftKlone Distributing Co.)
- #25994 MicroPhone 1.5 communications software \$159 (Support provided by Software Ventures Corp.)
- #25980 IBM PC or XT cable (5ft.) \$19.95
- #25981 IBM AT cable (5ft.) \$19.95
- #25982 Apple Macintosh Plus, SE or II cable (5 ft.) \$19.95
- #25983 Apple Macintosh cable (5 ft.) \$19.95



NEW! Patch Panel

- Access data circuits for network reconfiguration, service restoration, noninterruptive line monitoring and troubleshooting
- Convenient test access via patch cords makes network testing and maintenance easy
- Rack mountable with 16 patch modules to a rack. The 17th slot contains modules for testing and monitoring
- Compatible with RS-232, V.24, V.35 and RS-449 interfaces
- Transparent to all data paths
- Each patch provides normal through-connection and data patch interruption when patching DTE or DCE
- Gold contacts provide reliability
- LEDs monitor activity of TD, RD, and CD signals on RS-232 and V.35 lines
- Spectron compatible cabling
- Life-time warranty from Hadax

Hadax Patch Panel lets you access data circuits for network reconfiguration, troubleshooting and monitoring.

SPECIFICATIONS

Each rack contains 16 patching modules for patching and monitoring 16 independent interface pairs. Each module also contains 3 LEDs, monitoring, TD, RD and CD lines.

A test module is contained in slot #17 which allows monitoring of any of the 16 patch modules. The monitor LEDs indicate 11 signals: TXD, RXD, RTS, CTS, DSR, DCD, TC, RC, DTR, SQD, RI.

PATCHWORK System RS-232

RS-232 Patch Module with Monitoring LEDs: DTE/Female D25 DCE/Male connectors. Switches 24 leads Pin 1 common. Has three monitoring LEDs: TD, RD, CD.

Patch Test Module and Power Supply: Brings out the RS-232/V.24 to a standard D25 female connector on the rear of the module. LEDs on front panel monitor status of 11 RS-232 signals—TD, RD, RTS, CTS, DSR, DCD, TC, RC, DTR, SQD, RI.

PATCHWORK System V.35

V.35 Patch Module with Monitoring LEDs: Has V.35 attachments in rear. Wired for 18 conductor configuration. Three LEDs on front panel: TD, RD, CD.

V.35 Patch Test Module and Power Supply: Brings out V.35 to standard M type female connector on rear of module. Eleven LEDs on front panel monitor status of V.35 signals: TD, RD, RTS, CTS, DSR, DCD, TC, RC, DTR, SQD and RI.

TO ORDER

- #48740 RS-232 patch panel, 16 lines plus monitor
Qty. 1-5 \$1,805
6+ GC
- #48741 V.35 patch panel, 16 lines plus monitor
Qty. 1-3 \$2,810
4+ GC
- #48742 Patch cord (4 ft.)
Qty. 1-9 \$50
10+ \$48
- #48744 Patch Cord to DB 25 connector for interfacing to external devices (4 ft.)
Qty. 1-9 \$60
10+ \$58



Codex Express product returns will be accepted within 30 days of shipment by calling 1-800-446-6336 for a Return Authorization Number (RMA). We will issue a full refund or credit promptly upon receipt of your return. No return will be accepted without an RMA number. We reserve the right to refuse returns after 30 days.

**CALL CODEX EXPRESS
800-446-6336**

Customer Service

Codex stands behind each and every purchase you make!

Your association with Codex doesn't end once we ship your product. *Free of charge*, you get a year-long service warranty on most products. At the very least, your warranty will include a *Factory Repair and Return* guarantee and, in many cases, more flexible *Unit Exchange* or *On-Site Maintenance* guarantees are also "standard." To learn about the warranty that's standard with your product or for additional service pricing information, please refer to the chart below or call your Codex Express Representative at 800-446-6336.

Extend your standard warranty. . . and continue to get superior service from Codex

You can continue receiving our *award-winning customer service* beyond your standard warranty period. When you purchase your product, simply tell your Codex Express Representative which extended warranty option you'd prefer:

- For networks in which maximum uptime is absolutely critical, an **On-Site Maintenance** agreement is Codex's premium service offering, ensuring service response on the same Codex service day.
- The **Unit Exchange Maintenance Agreement** is usually chosen by customers with self-maintenance capabilities. Under this agreement, Codex will ship a replacement part on the same day that the equipment fails.

Installation and Maintenance Price Schedule

SAVE!

A Unit Installation Price
Your total installation charge will be the minimum site charge (\$195 if you're within 100 miles of a Codex service center; \$340 if greater than 101 miles) or the sum of the "per-unit" installation prices, whichever is greater.

B Service Level
The type of service that's "standard" (you pay no additional charge) with the warranty.

C Original Term Maintenance
The number of days you're covered by the standard warranty.

D CONTRACTED SERVICE On-Site Maintenance: Monthly Fee. You have the option of purchasing on-site maintenance if it's not included in the standard warranty (see column B for service level); or if you want to extend your warranty beyond the Original Term Maintenance "OTM."

E Unit Exchange: Monthly Fee
You may purchase unit exchange maintenance if it's not included in the standard warranty.

F Warranty Extension: 2- and 3-Year Plans

You also have the option of purchasing a 2- or 3-year plan for warranty extension at a *substantial savings* over the monthly fee. You can save up to 17% on the 2-year plan and up to 22% on the 3-year plan. Prepayment is required.

Product	Product Code	Unit Install. (one-time charge) A	Service Level B	Term (days) C	On-Site (monthly fee) D	Unit Exchange (monthly fee) E	Warranty Extension (2-year fee) F	Warranty Extension (3-year fee) G
DIAL MODEMS								
2234 Modem	402XX	\$ 56	Unit Ex.	365	8	\$ 6	\$119	\$ 168
2205/06 Modem	2589X	42	Unit Ex.	365	8	6	119	168
2219 Modem	25X54	42	Unit Ex.	365	8	6	119	168
222X Modem	25XXX	42	Unit Ex.	365	8	6	119	168
2233/38 Modem	4023X	56	Unit Ex.	365	8	6	119	168
2264 Modem	41700	40	Unit Ex.	365	7	6	119	168
LEASED LINE MODEMS								
2600 Series Modems	32XXX	74	On-Site	365	10	—	199	280
2500 Series Modems	266XX	65	On-Site	365	9	8	179	252
2320/40/21/41 Modems	262XX	64	On-Site	365	8	7	159	252
2362 Modem	263XX	65	On-Site	365	8	7	159	225
2382 Modem	3258X	74	On-Site	365	8	—	159	225
LIMITED DISTANCE MODEMS								
212X LDM	4XXXX	30	Unit Ex.	365	7	6	119	168
2111 LDM	481XX	38	Unit Ex.	365	6	4	79	112
2171/2 LDM	284XX	25	Unit Ex.	365	6	5	100	140
DIGITAL SERVICE UNITS								
2131/2132	485XX	40	On-Site	365	10	6	199	280
2150/60 DSU/CSU	485XX	40	On-Site	365	10	6	199	280
2020 Switched 56	485XX	50	On-Site	365	12	8	239	337
MULTIPLEXERS								
6015 INP	60150	150	On-Site	365	40	—	797	1123
6003 INP	603XX	135	Unit Ex.	365	35	8	159	983
6216 TDM	381XX	100	On-Site	365	30	—	598	842
6228 TDM	38XXX	150	On-Site	365	50	—	996	1404
OPTIONS AND ACCESSORIES								
2010 Dial Backup Unit	22326	24	On-Site	365	24	8	478	673
2185 (DSD)	47050	80	On-Site	365	6	5	119	168
Async to Sync Converter	47030	24	Unit Ex.	365	—	8	159	224
2025 A/B Switch	77997	10	Unit Ex.	365	6	5	100	140
6502	6554X	60	Unit Ex.	365	15	10	199	280

NON-CONTRACTED SERVICE

Time and Materials:

Service may be purchased by the hour on an "as needed" basis, with a 2-hour minimum charge.

Factory Repair and Return:

FR&R may be purchased as needed and is guaranteed for 30 days.

Direct Sales Offices

Networking Solutions from The Networking Experts

This is a partial list of the total product capabilities offered at Codex. Your Codex sales representative can fill you in on additional networking products and solutions not indicated here.

Your Requirements	Codex Products and Capabilities
Cut networking line costs, increase throughput for your data/voice/video applications, and build reliable, high-performance wide area networks (WANs) to optimize information processing and sharing.	Advanced multiplexers for both low-cost minicomputer networks and more complex, larger-scale networks. Field-proven time-division multiplexers for high-speed digital transmission and T1 nodal processors employing advanced fast packet technology.
Build inter-networking capabilities, streamline networks, and link network resources to the X.25 world and the world of public data networks.	Cost-effective concentrators, feeder devices and gateways to connect you to the world of X.25 and other public data networks, SNA environments, and other multi-vendor, multi-protocol networking applications.
Manage your network resources, optimize network performance and uptime, and plan effectively for future network growth.	Integrated network management systems for large-scale, complex networks and smaller modem and multiplexer networks. Centralized on-line network control and management service provides comprehensive network monitoring seven days a week, 24 hours a day, directly from Codex.
Lay a network foundation with reliable, high-performance transmission solutions, with or without built-in network control, by selecting from a comprehensive range of modems for virtually any application.	High-speed leased line modems deliver reliable data transmission with built-in network control at rates up to 19.2 kbps. Field-proven medium-speed leased line modems designed for economical performance. Dial modems for low- and medium-speed applications and V.32 dial modems delivering state-of-the-art performance for applications at speeds up to 9600 bps.

Alaska

Anchorage (907) 562-3204

Arizona

Scottsdale (602) 998-9436

California

San Mateo (415) 341-1616

Long Beach (213) 421-0086

Rancho Cordova (916) 635-2300

San Diego (619) 296-6283

Colorado

Westminster (303) 427-9600

Connecticut

Glastonbury (203) 633-9431/9432

Milford (203) 874-1965

Florida

Longwood (407) 869-5555

Boca Raton (407) 368-9114

Tampa (813) 931-3007

Georgia

Marietta (404) 952-9330

Idaho

Boise (208) 322-4800

Illinois

Chicago (312) 781-7320

Schaumburg (312) 576-2036

Indiana

Indianapolis (317) 842-7017

Iowa

W. Des Moines (515) 224-6851

Kansas

Shawnee Mission (913) 677-2002

Louisiana

Metairie (504) 885-7013

Maryland

Linthicum (301) 850-4546

Massachusetts

Westwood (617) 461-6161

Michigan

Troy (313) 649-4230

Minnesota

Minneapolis (612) 835-7927

Missouri

St. Louis (314) 863-1900

Nebraska

Omaha (402) 390-9600

New Hampshire

Nashua (603) 883-7843

New Jersey

Clifton (201) 470-9001

Mount Laurel (609) 778-5300

New York

Albany (518) 869-9517

New York City (212) 486-3000

Fairport (716) 223-7800

North Carolina

Greensboro (919) 373-1771

Charlotte (704) 522-6094/6095

Ohio

Cincinnati (513) 474-6614

Middleburg Heights (216) 886-4444

Columbus (614) 436-2370

Dayton (513) 298-1051

Oklahoma

Tulsa (918) 494-0126

Oregon

Portland (503) 245-7311

Pennsylvania

Downington (215) 873-8944/8945

Pittsburgh (412) 941-4235

Tennessee

Brentwood (615) 377-0740

Memphis (901) 767-3010

Texas

Austin (512) 346-1941

Dallas (214) 690-5221

Houston (713) 629-6910

Utah

Sandy (801) 944-1400

Virginia

Alexandria (703) 684-0400

Washington

Bellevue (206) 453-0510

Washington, D.C.

Alexandria, VA (703) 684-0400

Wisconsin

Milwaukee (414) 359-9210

FEDERAL GOVERNMENT

SALES

Virginia

Alexandria (703) 684-0400

Terms and Conditions of Sale

The following are the terms and conditions under which Codex provides equipment, Programs and services to Customer.

1. ORDERS

All orders are subject to acceptance by Codex at its general offices in Massachusetts. If Codex accepts an order which requests that a third party be billed, Codex may bill the third party but Customer shall remain fully obligated under these terms and conditions. Orders are cancellable only with Codex's written consent.

2. LIMITED EQUIPMENT WARRANTY

Codex warrants equipment, except consumable items, to be free from defects in materials and workmanship for either (i) twelve (12) months or (ii) ninety (90) days from shipment, as indicated in Codex's current Installation and Maintenance Price Schedule. If customer is provided with equipment that is not manufactured by Codex, only the warranty offered by the manufacturer will apply.

Codex will either replace or repair any defective item under the warranty or accept return of the item and refund the amount paid, at Codex's option and as the exclusive remedy, provided: (i) that the defect is not the result of an event after initial shipment, such as abuse, damage during shipment, alteration or accident; (ii) that the item is returned to the facility identified by Codex with transportation charges prepaid, unless the standard level of service (as shown in the Equipment Schedule) for the item is on-site; (iii) that Customer is not in breach of these terms and conditions or any agreement of which they are a part; and (iv) that all transactions under this warranty are directly between Customer and Codex.

THIS WARRANTY AND LIMITATION EXTENDS TO CUSTOMER AND TO USERS OF THE EQUIPMENT AND IS IN LIEU OF ALL OTHER WARRANTIES WITH RESPECT TO THE EQUIPMENT OTHER THAN THE WARRANTIES OF PARAGRAPH 5, WHETHER EXPRESS, IMPLIED OR STATUTORY, INCLUDING WITHOUT LIMITATION THE IMPLIED WARRANTIES OF MERCHANTABILITY AND FITNESS FOR A PARTICULAR PURPOSE.

3. DELIVERIES

All deliveries are FOB point of shipment and are only to locations within the United States. Risk of loss or damage and title (except as to Programs) shall pass to Customer upon shipment. Customer grants Codex a security interest in the equipment and will execute any document required to perfect it.

4. PAYMENTS

Terms are net thirty (30) days from invoice date (which is the shipping date for deliveries), unless Codex applies other credit terms. Prices do not include any transportation, installation, additional packaging, special handling nor like charges nor duties, levies nor taxes. Overdue amounts accrue interest at one and one-half percent (1.5%) per month or, if lower, the maximum legal rate. Customer shall pay Codex's costs and expenses, including without limitation attorneys' fees, in any enforcement of Codex's rights.

5. INFRINGEMENT INDEMNITY

Codex warrants that the use of equipment, Programs and documentation is free of infringement of any United States patent, copyright or other intellectual property right. In the event of a claim against Customer alleging such infringement, Codex shall defend and save Customer harmless from liability, as finally determined by a court of competent jurisdiction, for such infringement, provided that Codex is given full and exclusive control of the defense and the sole right to settle or compromise. If a final injunction is obtained against such use, Codex will, at its option, either (i) procure for Customer, at Codex's expense, the right to continue the use; (ii) replace or modify the item so that it is non-infringing; or, if (i) or (ii) cannot be accomplished using reasonable effort, allow return of such item to Codex, with Codex reimbursing the Customer the purchase price or fee originally paid less depreciation from delivery on a five-year straight line basis. Codex has no liability for any claim, suit or action arising out of non-standard specifications requested by Customer or the combination, operation or use of such items other than as designed by Codex or with items not furnished by Codex and not necessary to normal operation. **CODEX DOES NOT MAKE ANY OTHER WARRANTY TO CUSTOMER AS TO ANY CLAIM ALLEGING INFRINGEMENT OR THE LIKE, THESE REMEDIES BEING EXCLUSIVE.**

6. PROGRAMS

6.1. Certain Codex equipment contains as integral parts object code software embodied in read only memory ("ROM") devices (the "Programs"). Codex grants to Customer a non-exclusive license to use such Programs. Title to and all rights in the Programs remain vested in Codex or the owner. Customer shall treat the Programs, including methods or concepts used, as confidential information subject to the protections described in Paragraph 13. Any Program release, revision or enhancement subsequently delivered to Customer shall be deemed a Program licensed hereunder. If Customer receives software not embodied in a ROM device, then Customer agrees that it is licensed under Codex's standard Software License Agreement, which contains additional provisions and obligations.

6.2. Limited Program Warranty. Codex warrants that, for ninety (90) days after shipment of the first copy of each Program (whether or not shipped hereunder), the Program will conform to Codex's then current published program specifications for the most current release of the Program. Upon notice to Codex within such ninety (90) days, Codex will, at Codex's option and as Customer's exclusive remedy, either correct documented failures, replace the Program or accept return of the Program and refund to Customer any fees paid, provided: (i) that the defect is not the result of an event after initial shipment, such as abuse, damage during shipment, alteration or accident; or (ii) that customer is not in breach of these terms and conditions or any agreement of which they are a part. **THIS WARRANTY AND LIMITATION EXTENDS TO CUSTOMER AND TO USERS OF THE PROGRAMS AND IS IN LIEU OF ALL OTHER WARRANTIES WITH RESPECT TO THE PROGRAMS OTHER THAN THE WARRANTIES OF PARAGRAPH 5, WHETHER EXPRESS, IMPLIED OR STATUTORY, INCLUDING WITHOUT LIMITATION ANY CODEX EQUIPMENT WARRANTIES AND THE IMPLIED WARRANTIES OF MERCHANTABILITY AND FITNESS FOR A PARTICULAR PURPOSE. THIRD PARTY PROGRAMS PROVIDED BY CODEX THROUGH CATALOG ARE PROVIDED "AS-IS" WITHOUT WARRANTY.**

7. TEST AND ACCEPTANCE

Passage of standard final tests performed by the manufacturer at its facility shall be deemed to be acceptance. Upon request, Codex will provide written certification that the requirements of such tests were satisfied.

8. EXCUSABLE DELAYS AND FAILURES

Codex shall be excused for delays in performing and failures to perform to the extent resulting from any cause beyond its control, including without limitation delays caused by Customer or a third party, delays in the furnishing of site surveys, governmental regulations or catastrophes of nature, whether any such cause affects Codex or any supplier or provider of services to Codex.

9. WAIVER

IN NO EVENT SHALL CODEX BE LIABLE TO ANY PERSON, FIRM OR ENTITY, INCLUDING WITHOUT LIMITATION CUSTOMER, FOR INDIRECT, INCIDENTAL, PUNITIVE, EXEMPLARY OR CONSEQUENTIAL DAMAGES, INCLUDING WITHOUT LIMITATION LOST PROFIT, ARISING HEREUNDER, ARISING FROM THE POSSESSION OR USE OF ANY EQUIPMENT OR PROGRAM, ARISING FROM THE LOSS OF DATA OR USE, ARISING FROM ANY INFRINGEMENT OR ALLEGED INFRINGEMENT OF INTELLECTUAL PROPERTY RIGHTS OR ARISING OTHERWISE, EVEN THOUGH CODEX WAS NOTIFIED OF THE POSSIBILITY, LIKELIHOOD OR CERTAINTY THAT SUCH DAMAGES WOULD BE INCURRED, CUSTOMER HEREBY WAIVING SUCH DAMAGES. IN NO EVENT SHALL CODEX BE LIABLE TO ANY PERSON, FIRM OR ENTITY, INCLUDING WITHOUT LIMITATION CUSTOMER, FOR ANY LOSS, COST, DAMAGE OR EXPENSE ARISING FROM THE LOSS OF DATA, INTEGRITY OF DATA OR LOSS OF USE, CUSTOMER HEREBY WAIVING SUCH LOSSES, COSTS, DAMAGES AND EXPENSES.

10. USE OF EQUIPMENT

Customer warrants that the equipment and Programs are obtained solely for its own internal business use within the United States and not for the purposes of export, resale, lease or other transfer. If Codex authorizes export outside the United States, Customer shall fully comply with all laws and regulations with respect to installation and use, with all export laws, regulations and controls and with all economic sanctions imposed by the U.S. government against any other state, government or political entity.

11. MAINTENANCE, LEASE AND RENTAL

Any maintenance services, lease or rental of equipment hereunder shall be pursuant to the terms of Codex's standard Maintenance Services Agreement, Lease Agreement or Rental Agreement, unless otherwise agreed in writing.

12. DEFAULT

12.1. By notice of default to Codex, Customer may cancel any or all orders for undelivered equipment or Programs and/or any agreement of which these terms and conditions are a part if Codex does not correct any failure to fulfill any material obligation hereunder within thirty (30) days (or such longer period Customer may authorize in writing) after receipt of notice from Customer specifying such failure.

12.2. By notice of default to Customer, Codex may reject or cancel any orders for undelivered equipment or Programs and/or any agreement of which these terms and conditions are a part (i) if Customer fails to pay any amount when due; or (ii) if Customer does not correct any failure to fulfill any other material obligation hereunder within thirty (30) days (or such longer period Codex may authorize in writing) after receipt of notice from Codex specifying such failure.

13. PROPRIETARY INFORMATION

Customer shall treat any information disclosed to Customer hereunder, which is identified as confidential or proprietary, in strict confidence and shall not disclose such information to third parties or use it for any purpose other than the purpose for which it was disclosed to Customer.

14. NOTICES

All notices, consents, authorizations or waivers shall be in writing and shall be effective upon dispatch if by telex, telegram or similar means, upon delivery if by hand, and three days after deposit if deposited in the mails, postage prepaid. Notices to Codex shall be delivered to Codex Corporation, Attention: Vice President, U.S. Sales, Maresfield Farm, 7 Blue Hill River Road, Canton, Massachusetts 02021-1097, or such other address Codex may provide by notice. Notices to Customer shall be delivered to Customer at the address herein or a more recent address in Codex records.

15. GENERAL

Massachusetts law governs this transaction. Customer may not assign its rights or obligations without the written consent of Codex. Except as provided in a waiver signed by an authorized officer of the party seeking enforcement, the failure to enforce or the waiver of any term hereof shall not be a waiver of such term and shall not restrict or condition the prompt, full and strict enforcement of these terms. Customer acknowledges ownership by Codex or its vendors of software, trademarks, names, copyrights, patents and other such property so marked, so identified or so identifiable. Except as provided in a waiver signed by an authorized officer of Codex, Codex does not waive any proprietary right it may possess in any patent, copyright, computer program or technical data under any federal procurement law, regulation or contract clause. All information on Codex's standard acknowledgment of an order is subject to correction of typographical or clerical errors. 15.6. If Codex consents to the placement of equipment or Programs at a third party site, Customer shall obtain the agreement of the third party properly to use and protect information and Programs and Customer shall be fully responsible for such proper use and protection. These terms and conditions and any written agreement of which they form a part constitute the entire agreement between the parties with respect to the subject matter and supersede all prior discussions, documents, materials, understandings and agreements with respect to the subject matter and shall take precedence over any terms in Customer's purchase order or other documents, which terms are hereby rejected in their entirety.

**CALL CODEX EXPRESS
800-446-6336**

Telephone Order Guide

It's easy to order from Codex

To place your order... just dial 1-800-446-6336. We have knowledgeable sales representatives available to take your order and technical support staff to answer product questions from 8 a.m. to 8 p.m. ET, Monday through Friday.

Please do not mail this form!

When you call, please have this information ready for our Sales Representative:

- **Your Customer Order Number.** If your company has previously ordered from Codex, you were assigned a customer number. It appears as a 7-digit number in the upper left-hand corner of your invoice, under "Customer Order Number."
- **Your Tax Exempt Number** if applicable.
- **Who the order is billed to.** The company name, complete address, phone number and to whose attention.

**CALL CODEX EXPRESS
800-446-6336**

Product Information Worksheet

Quantity	Product Code	Description	Page	Unit Price <small>Based on quantity ordered.</small>	Extended Warranty <small>See page 57.</small>	Total
				\$	\$	\$

Prices: FOB origin. (Prices and product availability subject to change without notice.) Codex reserves the right to correct catalog printing errors.
Normal Shipping Terms: We ship to U.S. locations only. All products shipped by UPS unless otherwise specified. In-stock items are shipped within 24 hours of order.
Please note: Codex products are FCC-approved for business use only.

Select the Method of Payment Desired:

- Check or Money Order: (Make check payable to Codex Corporation) Freight charges will be billed separately, C.O.D.
- C.O.D.: We will ship your order cash-on-delivery (C.O.D.) if you wish.
- MasterCard, VISA or American Express.



- **Who the order is shipped to.** The complete company name, complete address, phone number and to whose attention.
- **Who initiated this order.** Name and address. Please let us know who has requested this order. The proper contact name allows us to send product information and pricing updates.

For New Customers Only

If your company has never ordered from Codex, your good credit listing with Dun & Bradstreet will speed your order through our system. If you're not listed with Dun & Bradstreet, please have the following information ready when you order (and allow a little extra time for credit authorization):

- **Bank information.** Your bank name, complete address and phone number, account number and contact name.
- **Supplier information.** The names of two of your major suppliers, their complete addresses, phone numbers, and a contact name at the supplier.

Federal Express

Need your products shipped in a hurry? We can ship in-stock products for overnight delivery! Ask us about it.

Please do not mail this form. The few minutes you take to complete this worksheet before you call will help speed your order.

You Can Charge It!



We have a new FAX number!

Just address your purchase order to "Codex Express" and dial our FAX number: 617-821-2662.

Product Returns

When you call for an RMA, please have the following information available: Your 7-digit customer order number (found on your invoice, packing list or on the box used for packaging). The serial numbers of the products you'd like to return (found on the packing list, on the equipment itself or on the box used for packaging).



Sub-Total	\$
Transit Insurance* <small>(1/2 of one percent of sub-total)</small>	\$
Sales Tax	\$
Total	\$

*Protect your new equipment in transit. The small amount you spend (1/2 of one percent of total order) will guarantee that the equipment we ship to you will be protected against common transit casualties.



Win the productivity race with the latest in data communications products from Codex Express!



This issue brings you new Codex modems, DSU/CSUs and digital bridging equipment to boost performance and productivity.

Turn to us when you're starting to develop a communications network, expanding an existing one or when you want to reduce costs.

Inside this catalog, you'll learn about the new Codex 2150/2160

Digital Service/Channel Service Units (pg.32). Now you can get integrated functionality in a single compact unit for network-managed point-to-point and multipoint digital service applications.

See the Codex 2500 Series modems for flexible, cost-effective network control in basic, leased line applications (pg. 29). With speeds up to 14.4 kbps and support for multipoint and point-to-point operation, the Codex 2500 Series modems are real "workhorses"—

with more standard features than you'll find in other comparably priced leased line modems.

For high-speed switched digital dial backups or disaster recovery applications, use the Codex 2020 Switched 56 Data Unit with ACCUNET™ (pg. 34).

Also, in the *Options and Accessories* section (pp. 41-48), you'll find the new Codex 2185 Digital Bridge, designed to speed transmission and make maximum use of your equipment.

Plus a selection of quality products from leading vendors—all available just by calling 800-446-6336!

Our selection of quality products from other vendors can be found in the *Etcetera* section starting on page 49. In our *Etcetera* section, you'll find manual data switches that reduce cable hassles and enable you to share costly equipment; V.35 converters to end communications barriers; a patch panel that makes troubleshooting your network easier. To order, call 800-446-6336. Questions? Call the Codex Helpline at the same toll-free number. We're here to help you succeed!



Codex introduces a new Data Service/Channel Service Unit that adds functionality to improve network-managed point-to-point and multipoint applications! New integrated DSU/CSUs assure reliable large-system networking in point-to-point and multipoint applications. They may be used as cost-effective alternatives to modems.

The Codex 2150/2160 interface between system and digital links delivers the 99.5% data accuracy associated with high-performance DDS transmission. Each unit operates under Codex Network Management with async/sync transmission and unattended remote testing. See page 33 for details.

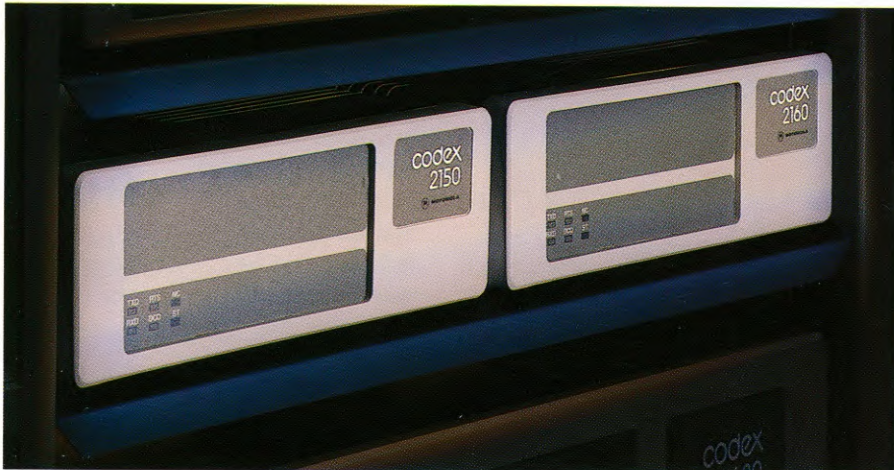

Need applications assistance? Not sure which product is best for your system? We're here to help—Just call 800-446-6336 with all your data communications questions.

Our Applications Specialists are standing by to answer your questions, help solve your problems and ensure you get exactly the product you need. Call 800-446-6336 for free technical assistance.

Save time by faxing your purchase order...to our new fax number!

Just dial 617-821-2662 to fax your purchase order directly to Codex Express!

Codex Corporation
Maresfield Farm
7 Blue Hill River Road
Canton, MA 02021-1097

Address Correction Requested

Bulk Rate
U.S. Postage
PAID
Codex Corp.

Route to: Data Communications Data Processing Manager _____